

HYDRAULIC POP-UP BOX, CABLE CUBBY FLOOR BOX, POWER DOCK & POWER TRACK & ACCESSORIES

Divya Electricals
Chennai

Contact:

9841260168

96009984212

044-4216 5795

divyaelectricalschennai@yahoo.co.in

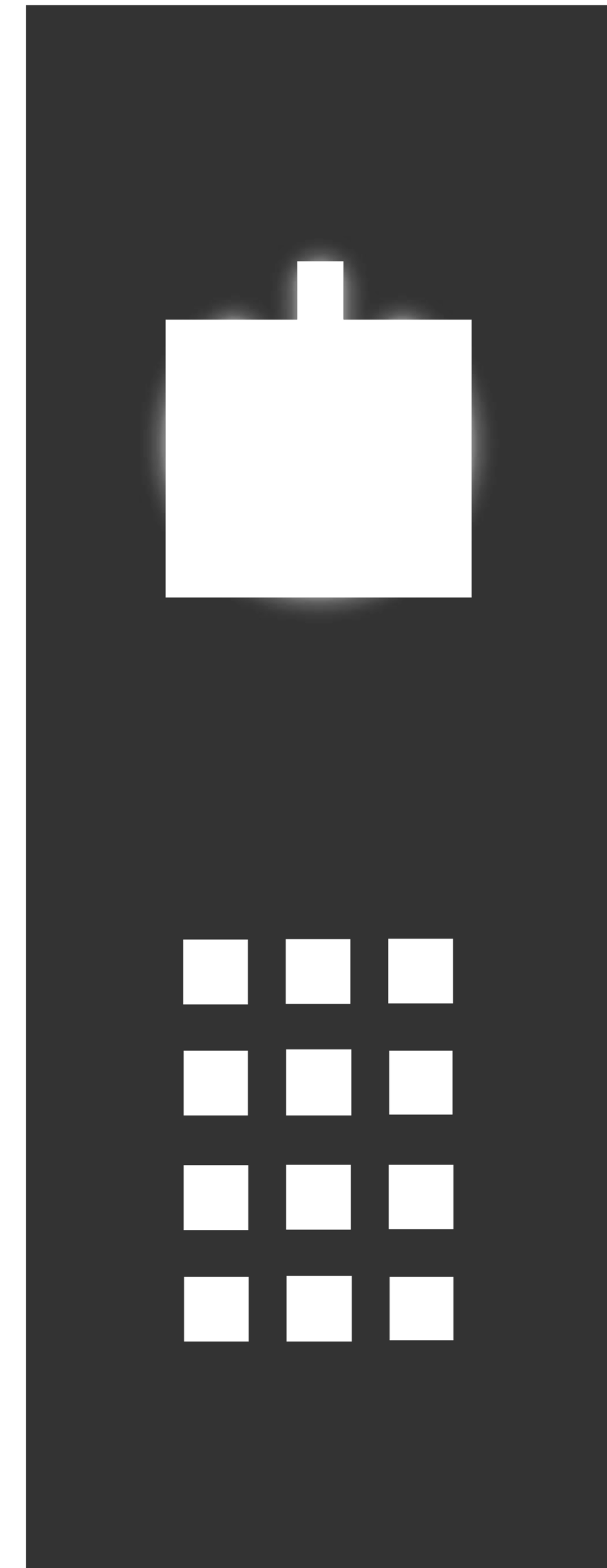

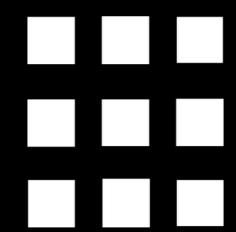

OUR RANGE OF POP-UP & FLOOR BOX

- HYDRAULIC BULIT-IN POP UP BOX
- HYDRAULIC POP UP CUSTOMISABLE
- ELECTRIC CABLE CUBBY
- ACCESS FLAP COVER FOR CABLE CUBBY
- SLIDE SERIES CABLE CUBBY
- POWER DOCKS
- MOTORISED TURN POWER DOCK
- ROUND POP UP BOX
- POWER TRACKS
- CABLE MANAGER/VERTEBRE
- ELECTRIC FLOOR BOX
- SWITCH, SOCKET & ACCESSORIES

HYDRAULIC BUILT-IN POP UP BOX

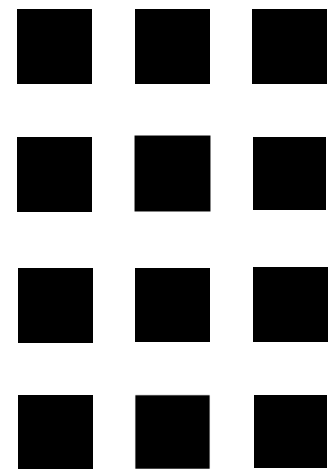

| | | | |
|----------------------|--|--|--|
| Product Code | Q0314 SILVER | Q0314 BLACK | |
| Features | Elegant and Spacious Brushed silver finish pop up box with self push unlock with prefixed accessories. | Elegant and Spacious Brushed silver finish pop up box with self push unlock with prefixed accessories. | |
| Color | Brushed Silver | Brushed Silver | |
| Configuration | 2 x universal Socket, 2 x Data, 1 x Hdmi, 1 x Usb, 1 x audio | 2 x universal Socket, 2 x Data, 1 x Hdmi, 1 x Usb, 1 x audio | |
| Installation | Workstation/Conference | Workstation/Conference | |

HYDRAULIC BUILT-IN POP UP BOX

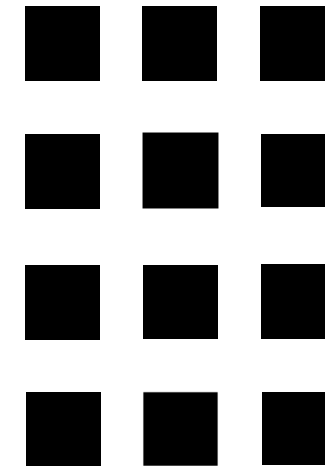

| | | |
|----------------------|---|--|
| Product Code | Q514 R/S, R/B | Q514 S/S, S/B |
| Features | It has round edges and slim top of 2 mm with prefixed accessories | It has square edges with prefixed accessories. |
| Color | Silver/Black | Silver/Black |
| Configuration | 2 x universal Socket, 2 x Data, 1 x Hdmi, 1 x Usb, 1 x audio | 2 x universal Socket, 2 x Data, 1 x Hdmi, 1 x Usb, 1 x audio |
| Installation | Workstation/Conference | Workstation/Conference |

HYDRAULIC BUILT-IN POP UP BOX



All In One Power Connectivity Box

2 AC Outlets, 2 Network
1 HDMI, 1 USB-A, 1 VGA, 1 Audio

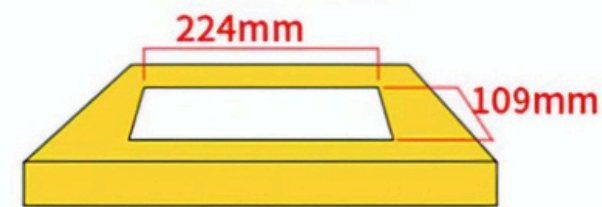

generated content.

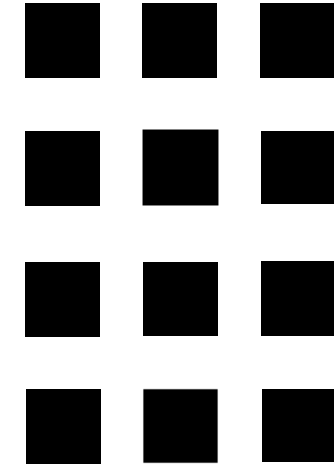

AI-generated content.



| | | |
|----------------------------|---|---|
| <p>Product Code</p> | <p>Q5043SACRS Q5043SACRB</p> | <p>Q5044SRS Q5044SRB</p> |
| <p>Features</p> | <p>ROUND EDGE POP UP BOX WITH PRE-FIXED 3X UNIVERSAL SOCKET, 1X USB (A+C)</p> | <p>ROUND EDGE POP UP BOX WITH PRE-FIXED 4X UNIVERSAL SOCKET</p> |
| <p>Color</p> | <p>SILVER/BLACK</p> | <p>SILVER/BLACK</p> |

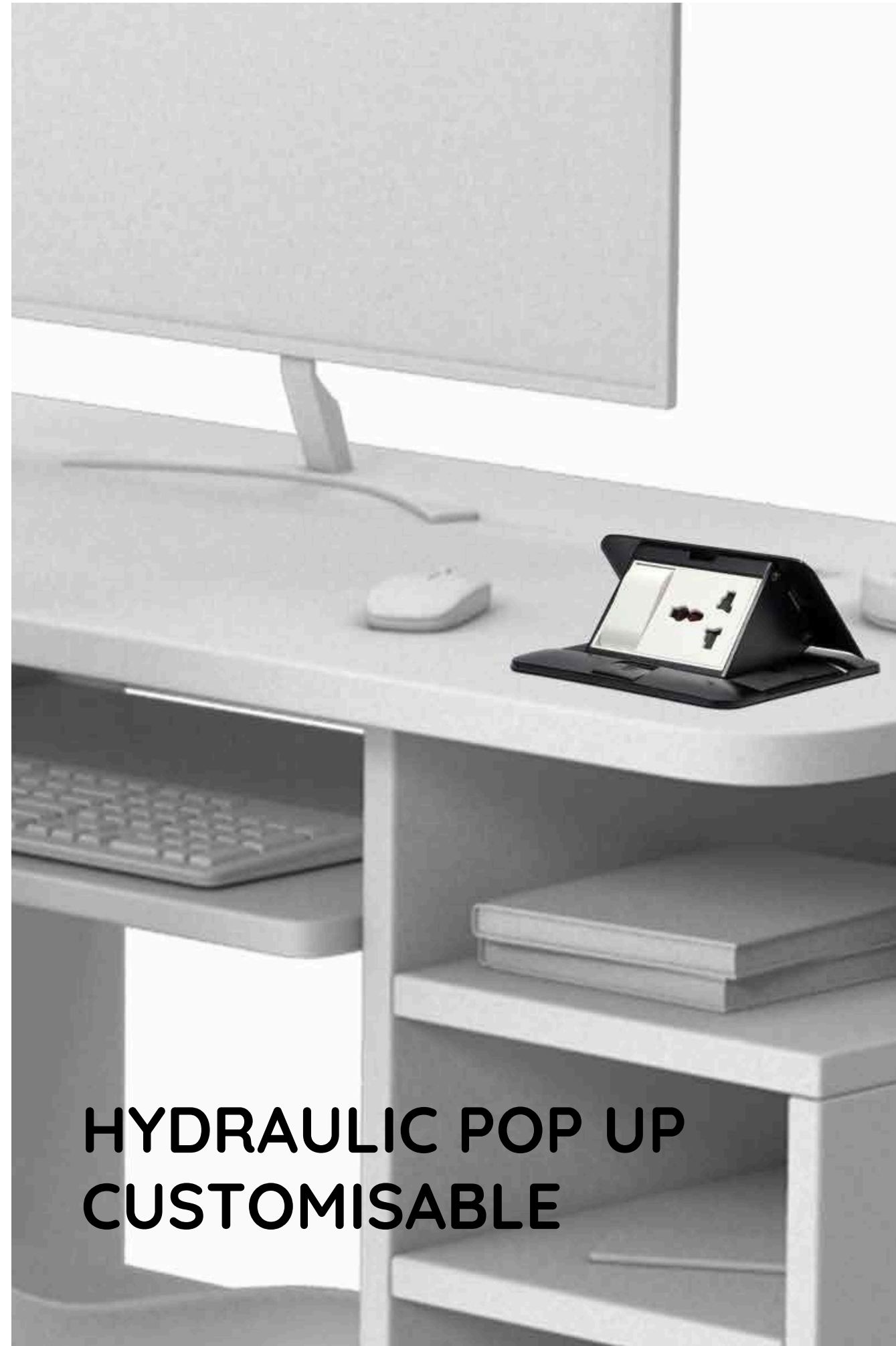

**HYDRAULIC POP UP
CUSTOMISABLE**

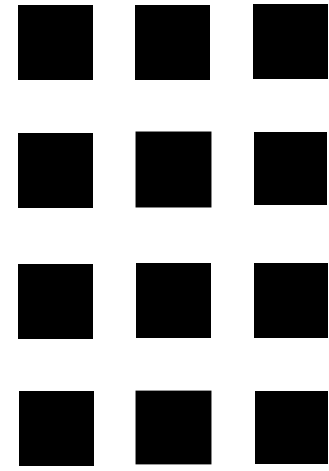

| | |
|----------------------|--|
| | QLG03AL/BK/WH/GL/SS |
| Product Code | Soft open hydraulic pop up box with space of 3m accessories |
| Features | Aluminium/Black/White/Brass /stainless steel |
| Color | 3M with Floor box |
| Configuration | Workstation/Conference/ floor mount |
| Installation | |



**HYDRAULIC POP UP
CUSTOMISABLE**

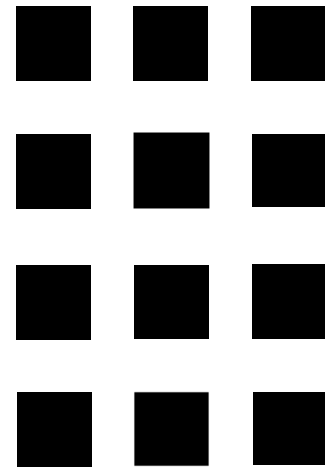

| | |
|----------------------|--|
| Product Code | QLG04AL/BK/WH/GL/SS |
| Features | Soft open hydraulic pop up box with space of 4m accessories |
| Color | Aluminium/Black/White/Grey/Brass/ stainless steel |
| Configuration | 4M with Floor box |
| Installation | Workstation/Conference/ floor mount |



**HYDRAULIC POP UP
CUSTOMISABLE**

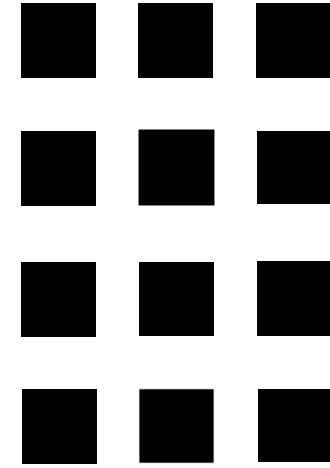

| | |
|-----------------------------|--|
| <p>Product Code</p> | <p>QLG06SL/BK/WH/GR/GL</p> |
| <p>Features</p> | <p>Soft open hydraulic pop up box with space of 6m accessories</p> |
| <p>Color</p> | <p>Silver/Black/White/Grey/ Chamange</p> |
| <p>Configuration</p> | <p>6M with Floor box</p> |
| <p>Installation</p> | <p>Workstation/Conference/ floor mount</p> |

HYDRAULIC POP UP CUSTOMISABLE

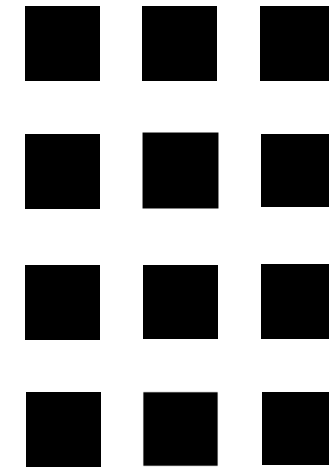

| | |
|----------------------|---|
| Product Code | QLG06AL/BK/WH/GL/SS |
| Features | Soft open hydraulic pop up box with space of 3+3=6m accessories |
| Color | Aluminium/Black/White/Brass/stainless steel |
| Configuration | 3+3=6M with Floor box |
| Installation | Workstation/Conference/floor mount |



**HYDRAULIC POP UP
CUSTOMISABLE**

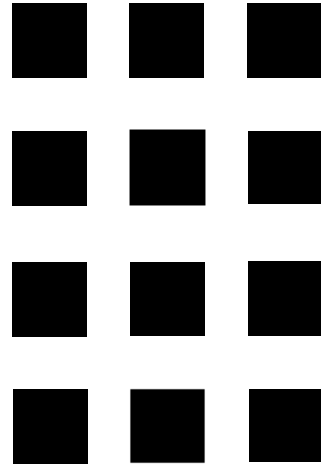

| | |
|-----------------------------|--|
| <p>Product Code</p> | <p>QLG08AL/BK/WH/GL/SS</p> |
| <p>Features</p> | <p>Soft open hydraulic pop up box with space of 4+4=8m accessories</p> |
| <p>Color</p> | <p>Silver/Black/White/Grey/ Chamange</p> |
| <p>Configuration</p> | <p>4+4=8M with Floor box</p> |
| <p>Installation</p> | <p>Workstation/Conference/ floor mount</p> |

HYDRAULIC POP UP CUSTOMISABLE

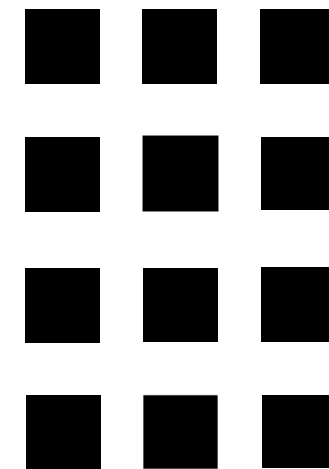

| | |
|-----------------------------|--|
| <p>Product Code</p> | <p>QLG09AL/BK/WH/GL/SS</p> |
| <p>Features</p> | <p>Soft open hydraulic pop up box with space of 8m accessories</p> |
| <p>Color</p> | <p>Silver/Black/White/Grey</p> |
| <p>Configuration</p> | <p>8M pop- up with back box</p> |
| <p>Installation</p> | <p>Workstation/Conference/ floor, wall</p> |



**ELECTRIC
CABLE CUBBY**

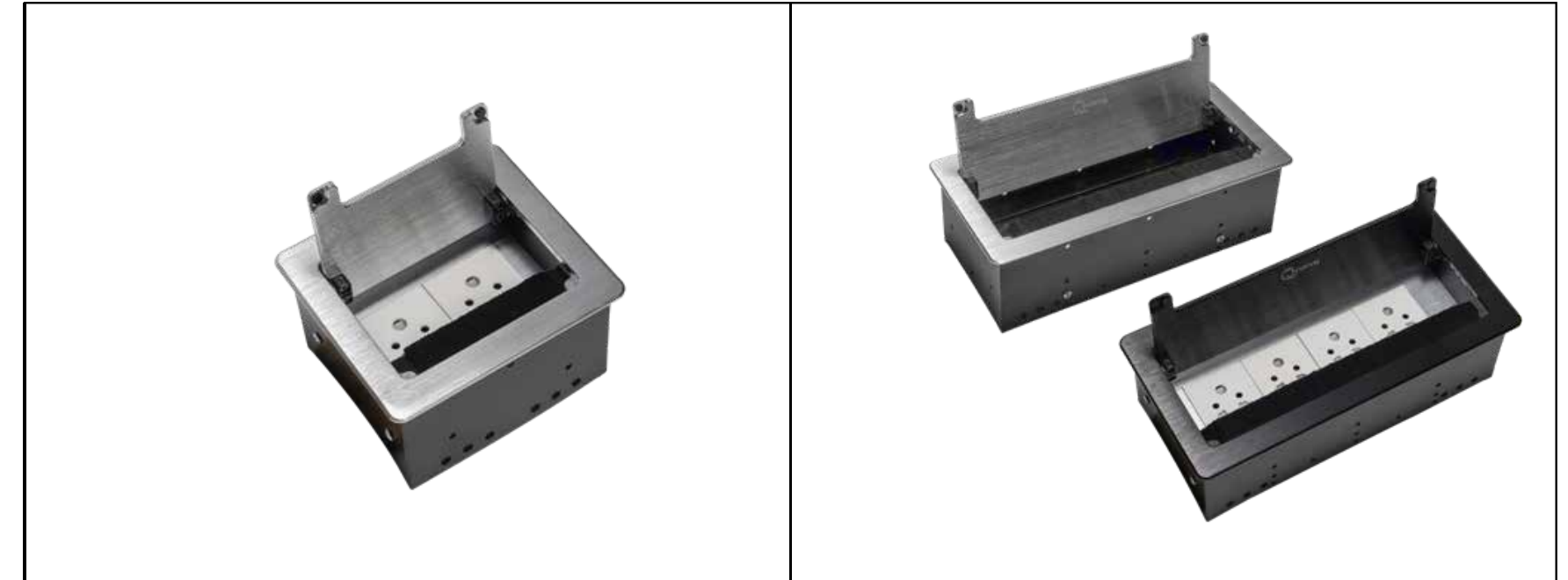
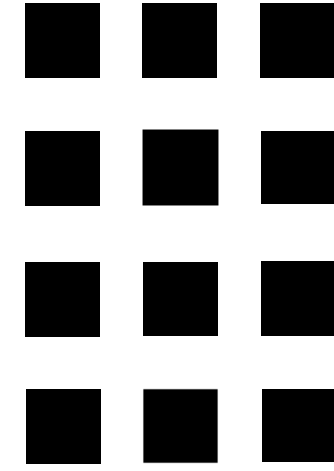

| | | |
|-----------------------------|---|---|
| | | |
| <p>Product Code</p> | <p>Q205</p> | <p>Q215</p> |
| <p>Features</p> | <p>Brush finish access flap soft close with Legrand/Roma 4m fixing option</p> | <p>Brush finish access flap soft close with Legrand/Roma 8m fixing option</p> |
| <p>Configuration</p> | <p>4 modules</p> | <p>8 modules</p> |
| <p>Color</p> | <p>Brushed Silver/ Black</p> | <p>Brushed Silver/ Black</p> |

ELECTRIC CABLE CUBBY

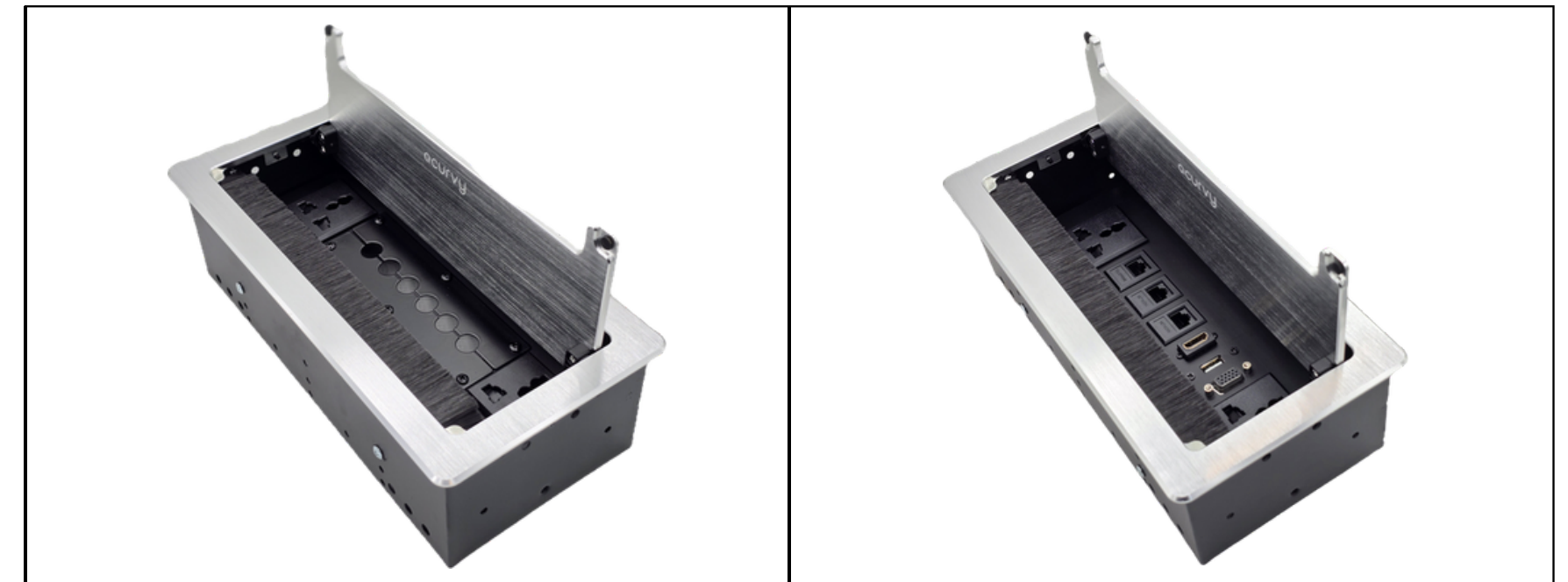
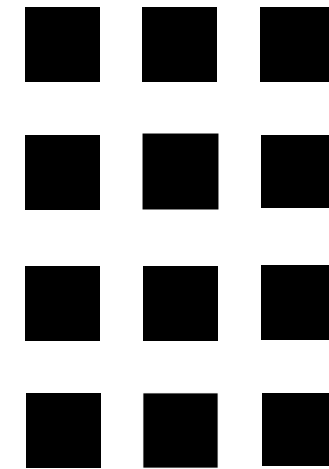

| | | |
|-----------------------------|--|--|
| <p>Product Code</p> | <p>Q2152S6H-SL Q2152S6H-BK</p> | <p>Q215COMP-SL Q215COMP-BK</p> |
| <p>Fetaures</p> | <p>Cable cubby soft close brush finish pre-fixed 2 x Universal Socket, 6 x Pass through hole</p> | <p>Cable cubby soft close brush finish pre-fixed 2 x Universal Socket, 2 x Data, 1 x Tele, 1 x HDMI, 1 x USB Data, 1 x vga</p> |
| <p>Configuration</p> | <p>10m</p> | <p>12m</p> |
| <p>Color</p> | <p>Silver/Black</p> | <p>Silver/Black</p> |

ELECTRIC CABLE CUBBY

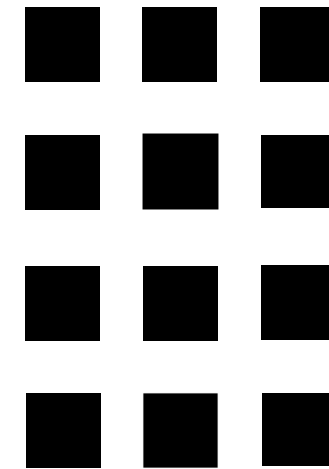

qcurvy
WITH YOUR SOLUTION



Boosts Efficiency



Energy Saving



Safe and Reliable



Versatile Solutions



Modern Tech



Aesthetic Design



www.qcurvy.com



| | | |
|----------------------|--|--|
| Product Code | Q315 - SL | Q315-BK |
| Features | Cable cubby Flip open and glide in cover - soft open/close. Top aluminum brush finish cover with pre-fixed 2 x Universal Socket, 2 x A+C usb chargers 6 x Pass through hole. | Cable cubby Flip open and glide in cover - soft open/close. Top aluminum brush finish cover with pre-fixed 2 x Universal Socket, 2 x A+C usb chargers 6 x Pass through hole. |
| Configuration | INBUILT | INBUILT |
| Color | Silver | Black |



Step up cable cubby
USB-A & USB-C, HDMI port



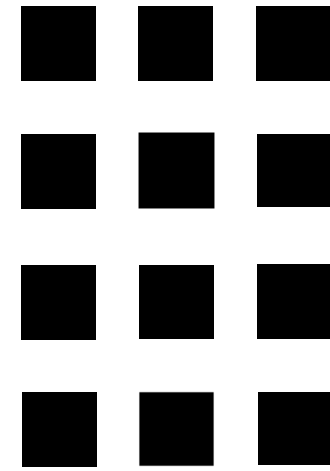

www.qcurvy.com

ELECTRIC CABLE CUBBY

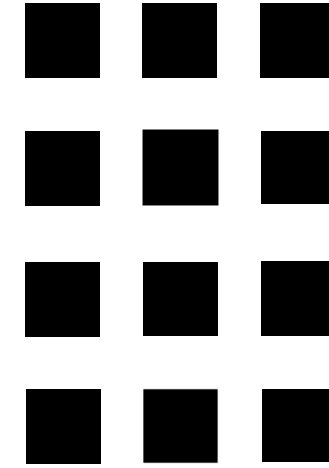

| | | |
|-----------------------------|---|---|
| <p>Product Code</p> | <p>Q415-WH 8M/10M/12M</p> | <p>Q415- BK 8M/10M/12M</p> |
| <p>Features</p> | <p>white colour step up pop up box. can be hold on 5 different steps. with inbuilt modules.</p> | <p>Black colour step up pop up box. can be hold on 5 different steps. with inbuilt modules.</p> |
| <p>Configuration</p> | <p>8M -2* SOCKET, 1*A+C USB CHARGER, 1*DATA, 1*HDMI 10M -3* SOCKET, 1*A+C USB CHARGER, 1*DATA, 1*HDMI 12M -3* SOCKET, 1*A+C USB CHARGER, 3*DATA, 1*HDMI</p> | <p>8M -2* SOCKET, 1*A+C USB CHARGER, 1*DATA, 1*HDMI 10M -3* SOCKET, 1*A+C USB CHARGER, 1*DATA, 1*HDMI 12M -3* SOCKET, 1*A+C USB CHARGER, 3*DATA, 1*HDMI</p> |
| <p>Color</p> | <p>Brushed Silver/ Black</p> | <p>Brushed Silver/ Black</p> |

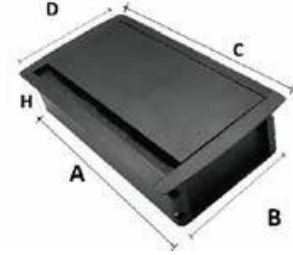
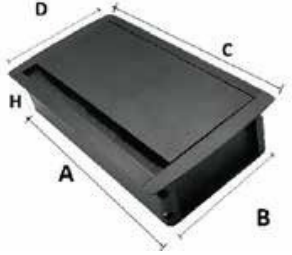

| | | |
|--|--|---|
|  |  | |
| <p>Product Code</p> <p>Features</p> <p>Configuration</p> <p>Dimensions</p> <p>Color</p> | <p>QR06</p> <p>Eco flap access manual with inbuild provision for Roma Sizes 6M, 8M, 10M and 12M.</p> <p>6m</p> <p>A 216mm B 132 mm C 232 mm D 154 mm H 50 mm</p>  <p>White, Grey and Black</p> | <p>QR08</p> <p>Eco flap access manual with inbuild provision for Roma Sizes 6M, 8M, 10M and 12M.</p> <p>6m</p> <p>A 266 mm B 132 mm C 282 mm D 154 mm H 50 mm</p>  <p>White, Grey and Black</p> |



**ELECTRIC
CABLE CUBBY**

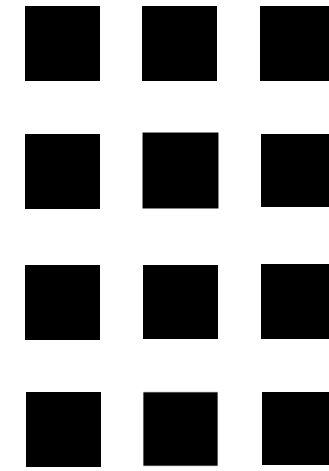

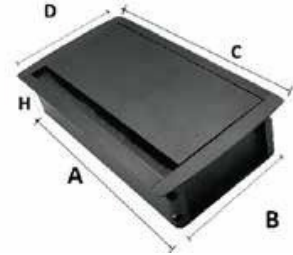
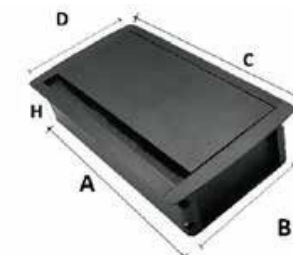
| | | |
|-----------------------------|--|--|
| <p>Product Code</p> | <p>QR10</p> | <p>QR12</p> |
| <p>Features</p> | <p>Eco flap access manual with inbuild provision for Roma Sizes 6M, 8M, 10M and 12M.</p> | <p>Eco flap access manual with inbuild provision for Roma Sizes 6M, 8M, 10M and 12M.</p> |
| <p>Configuration</p> | <p>10m</p> | <p>12m</p> |
| <p>Dimensions</p> | <p>A 316 mm B 132 mm C 332 mm D 154 mm H 50 mm</p>  | <p>A 366 mm B 132 mm C 382 mm D 154 mm H 50 mm</p>  |
| <p>Color</p> | <p>White, Grey and Black</p> | <p>White, Grey and Black</p> |



**FLAP COVER
FOR CABLE CUBBY**

| | |
|--|---|
| | |
| <p>Product Code</p> <p>Fetaures</p> <p>Color</p> <p>Configuration</p> <p>Installation</p> | <p>Q1227N-300 SL/BK/WH Q1227N-450 SL/BK/WH Q1227N-600 SL/BK/WH</p> <p>Aluminium Acess Flap with Soft Close Damper outer size 300X 127MM, 450 X 127MM & 600X 127MM</p> <p>White, Silver, Black</p> <p>NA</p> <p>Workstation/Conference</p> |

FLAP COVER FOR CABLE CUBBY

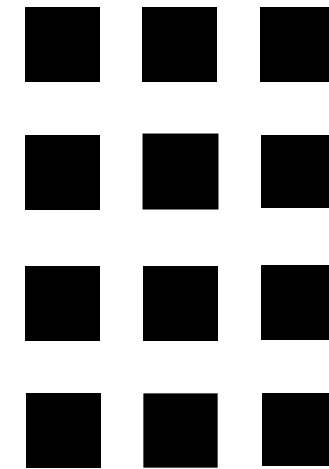

| | | |
|----------------------|---|-----------------------------------|
| Product Code | Q1227P 300 SL/BK/WH | Q1227DUAL - SL Q1227DUAL - BK |
| Features | Access flap soft close rigid PVC Silver color | Brush finish flap open both sides |
| Color | White, Silver, and black | Silver and Black |
| Configuration | NA | NA |
| Installation | Workstation/Conference | Workstation/Conference |



SLIDE SERIES CABLE CUBBY

+91 7777059932

info@qcurvy.in

318, Daruwalla Building, opp. Lady
Marine Lines (E) Mumbai - 400002

| | |
|--|---|
| | |
| <p>Product Code</p> <p>Features</p> <p>Color</p> <p>Configuration</p> <p>Installation</p> | <p>Q1300</p> <p>Premium sleekest design slide up cable cubby with magnet assist.</p> <p>White/black/ champagne</p> <p>6module customisable</p> <p>Workstation/Conference</p> |

SLIDE SERIES CABLE CUBBY BUILT IN

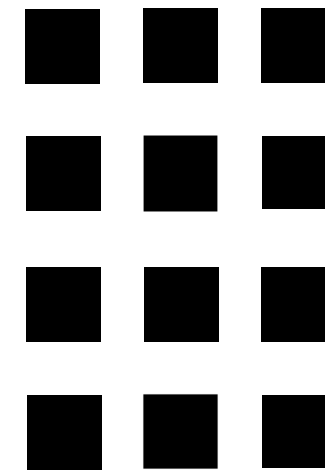

| | | |
|-----------------------------|---|---|
| <p>Product Code</p> | <p>Q1323</p> | <p>Q1324</p> |
| <p>Features</p> | <p>Premium slide to use sparkling silver with lowest depth of 25mm and prefixed accessories</p> | <p>Premium slide to use sparkling silver with lowest depth of 25mm and prefixed accessories</p> |
| <p>Color</p> | <p>Silver/black</p> | <p>Silver/black</p> |
| <p>Configuration</p> | <p>3 x Universal socket, 1x HDMI, 1x data</p> | <p>1x Wireless charger, 2 x Universal socket, 1 x Dual usb(A+C), 1x HDMI, 1 x Data</p> |
| <p>Installation</p> | <p>Workstation/Conference</p> | <p>Workstation/Conference</p> |



| | | | |
|--|--|--|--|
| | | | |
| <p>Product Code</p> <p>Fetaures</p> <p>Configuration</p> <p>Installation</p> | <p>QINT06/08/10/12</p> <p>Sleek & slim design mount inside table on top. It supports to Fix Qcurvy and Arteor switches inside.</p> <p>6m/8m/10m/12m/cust</p> <p>Workstation/ office table/ conference table</p> | <p>QCMP06/08/10/12</p> <p>Clamp mount Power dock. it can be customised as per request. It can be mount on any edge of the table without any whole on table</p> <p>6m/8m/10m/12m/cust</p> <p>Workstation/ office table/ conference table</p> | <p>QUDP06/08/10/12</p> <p>Clamp mount Power dock. it can be customised as per request. It can be mount on any edge of the table without any whole on table</p> <p>6m/8m/10m/12m/cust</p> <p>Workstation/ office table/ conference table</p> |

Motorised Turn power Dock

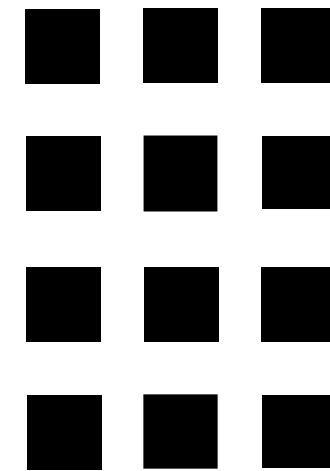

| | | |
|-----------------------------|--|--|
| <p>Product Code</p> | <p>QMP5000 SL/ BK</p> | <p>QMP5100 SL/ BK</p> |
| <p>Features</p> | <p>Motorized smooth turn Mechanism on the touch to open and close the box. space saving design with anti pinch sensor. one piece top Aluminium frame for strong and seamless look.</p> | <p>Motorized smooth turn Mechanism on the touch to open and close the box. space saving design with anti pinch sensor. one piece top Aluminium Brush finish Anodised frame for strong and seamless look.</p> |
| <p>Color</p> | <p>Silver / Black</p> | <p>Silver / Black</p> |
| <p>Configuration</p> | <p>3 x Universal Socket 1 x Dual USB (A+C) 30W 1 x cat 6 , 1x HDMI</p> | <p>2 x Universal socket 1 x Dual usb(A+C) 20W 3 x cat 6 , 1x type C data, 1x HDMI</p> |
| <p>Application</p> | <p>Conference rooms/Study table / Offices / Hotels/ Workstations</p> | <p>Conference rooms/Study table / Offices / Hotels/ Workstations</p> |

**ROUND PUSH- TO- UP
POP-UP BOX**

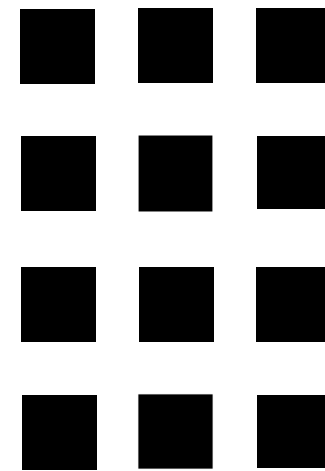

| | | |
|----------------------|---|---|
| Product Code | Q4000 WH /BK | Q4100 WH /BK /GR |
| Features | Round Push-up power dock. It lifts up with the help of pneumatic inside. easy to install with surge protection. | Round Push-up power dock. It lifts up with the help of pneumatic inside. easy to install with surge protection. |
| Color | White / Black | White/ Black / Grey |
| Configuration | 4 x Universal socket | 1x Wireless charger 15W 4 x Universal socket 1 x Dual usb(A+C) 30W |
| Installation | Workstation/Conference/Study table / Director table/ sofa/ Bedside | Workstation/Conference/Study table / Director table/ sofa/ Bedside |

ROUND PUSH- TO- UP POP-UP BOX

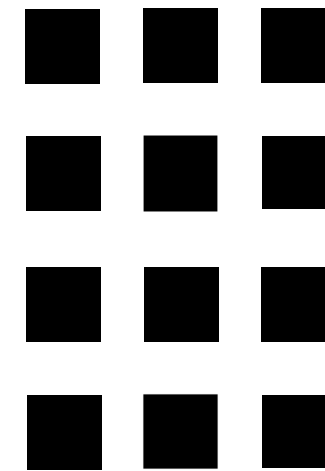

| | | |
|-----------------------------|--|--|
| <p>Product Code</p> | <p>Q4500 WH / BK</p> | <p>Q4200 WH / GR +BK</p> |
| <p>Features</p> | <p>Round Push-up power dock. It lifts up with the help of pneumatic inside. easy to install with surge protection.</p> | <p>Round Push-up power dock. It lifts up with the help of pneumatic inside. easy to install with surge protection.</p> |
| <p>Color</p> | <p>white/ Black</p> | <p>White / Grey + Black</p> |
| <p>Configuration</p> | <p>4 x Universal socket 2 x Type A USB Charger on Top 1 x Type C USB Charger on Top</p> | <p>1x Wireless charger, 2 x Universal socket, 1 x Dual usb(A+C), 1x HDMI, 1 x Data</p> |
| <p>Installation</p> | <p>Workstation/Conference/Study table / Director table/ sofa/ Bedside</p> | <p>Workstation/Conference/Study table / Director table/ sofa/ Bedside</p> |

ROUND TWIRL POWER DOCK

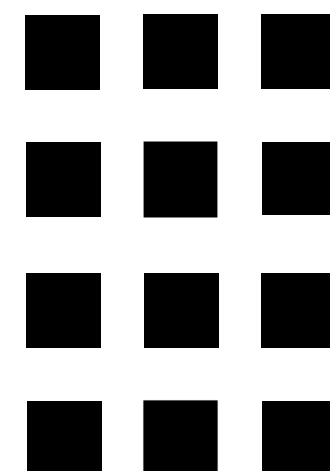
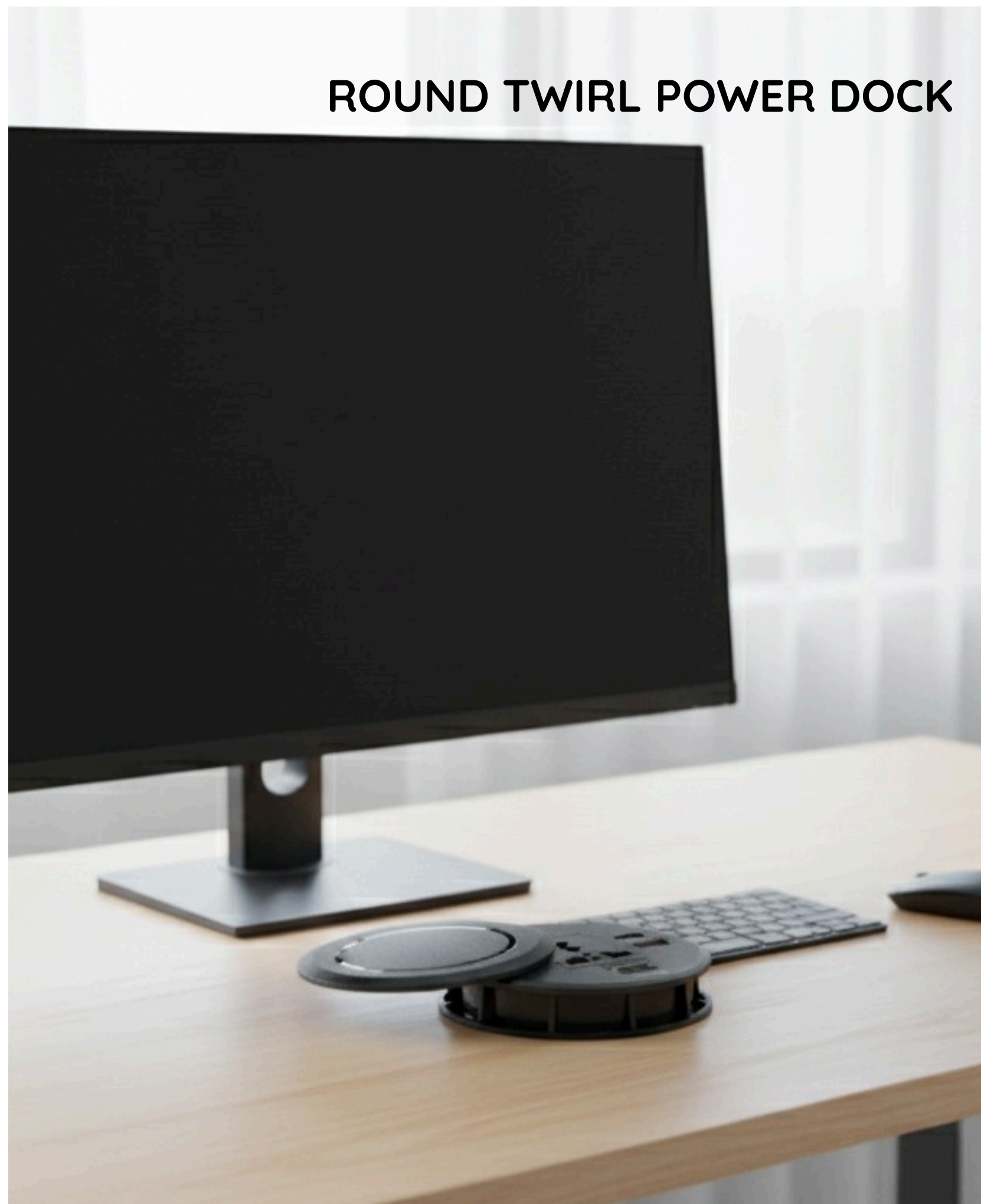

| | | |
|-----------------------------|--|--|
| <p>Product Code</p> | <p>Q4800 WHITE</p> | <p>Q4800 BLACK</p> |
| <p>Features</p> | <p>Round Twirl power dock. Mini and small power dock with flap cover, Easy to Install.</p> | <p>Round Twirl power dock. Mini and small power dock with flap cover, Easy to Install.</p> |
| <p>Color</p> | <p>white</p> | <p>Black</p> |
| <p>Configuration</p> | <p>1 x Universal socket 1 x Type A + C USB Charger 1 x Cat6 , 1x Hdmi</p> | <p>1 x Universal socket 1 x Type A + C USB Charger 1 x Cat6 , 1x Hdmi</p> |
| <p>Installation</p> | <p>Workstation/Conference/Study table / Director table/ sofa/ Bedside</p> | <p>Workstation/Conference/Study table / Director table/ sofa/ Bedside</p> |



Mini stretch-up box

| | |
|--|---|
| | |
| <p>Product Code</p> <p>Fetaures</p> <p>Color</p> <p>Configuration</p> <p>Installation</p> | <p>Q4400 Black</p> <p>Oval Shaped Sleekest power Dock. push open and lays flat on table. it has a option of adding pass trough on both the side,</p> <p>Black</p> <p>2 x Universal socket 1 x Type A + C USB Charger</p> <p>Workstation/Conference/Study table / Director table/ sofa/ Bedside</p> |

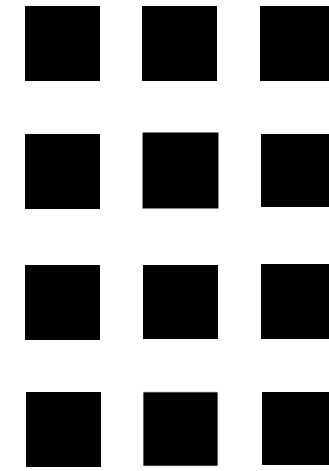

| | | |
|-----------------------------|---|---|
| | | |
| <p>Product Code</p> | <p>QPO6100 6M BK</p> | <p>QPO6100 8M BK</p> |
| <p>Features</p> | <p>Round Pull out vertical power dock. Mini and long power dock cover, Easy to Install.</p> | <p>Round Pull out vertical power dock. Mini and long power dock cover, Easy to Install.</p> |
| <p>Color</p> | <p>black</p> | <p>Black</p> |
| <p>Configuration</p> | <p>Module capacity : 6M</p> | <p>Module capacity : 8M</p> |
| <p>Installation</p> | <p>Workstation/Conference/Study table / Director table/ sofa/ Bedside</p> | <p>Workstation/Conference/Study table / Director table/ sofa/ Bedside</p> |

ELECTRIC POWER TRACK AND SOCKETS

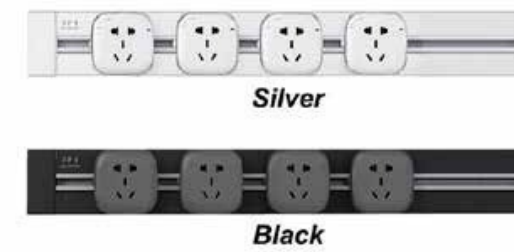
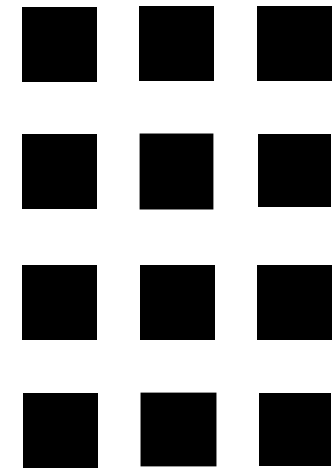

| | | | |
|--|--|--|--|
| <p>Product Code</p> <p>Features</p> <p>Length</p> <p>Color</p> | <p>QTR06-SL QTR06-BLK</p> <p>Power track which gives full flexibility to use sockets and USB chargers at your comfortable place with surge protection upto 16A</p> <p>0.6MTR (600mm)</p> <p>SILVER/BLACK</p> | <p>QTR10-SL QTR10-BK</p> <p>Power track which gives full flexibility to use sockets and USB chargers at your comfortable place with surge protection upto 16A</p> <p>1.0MTR (1000MM)</p> <p>SILVER/BLACK</p> | <p>QTR15-SL QTR15-BK</p> <p>Power track which gives full flexibility to use sockets and USB chargers at your comfortable place with surge protection upto 16A</p> <p>600, 800, 1000 CM</p> <p>SILVER/BLACK</p> |
|--|--|--|--|

ELECTRIC POWER TRACK AND SOCKETS

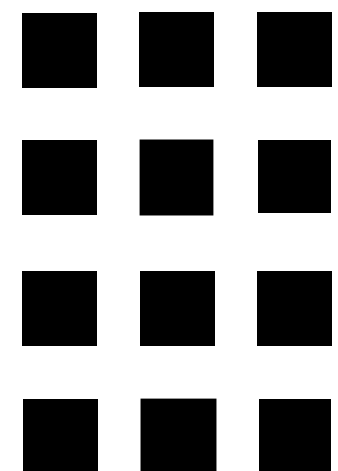

| | |
|---|--|
|  |  |
| <p>Product Code</p> <p>QTRS13-WH QTRS13-BK</p> <p>Features</p> <p>6/13A INTERNATIONAL SOCKET PLUG TWIST AND USE</p> <p>Color</p> <p>SILVER/BLACK</p> | <p>Product Code</p> <p>QTRU24-WH QTRU24-BK</p> <p>Features</p> <p>2 X 2.4AMPS USB CHARGER PLUG TWIST AND USE</p> <p>Color</p> <p>SILVER/BLACK</p> |



POWER TRACK WITH LED LIGHT & SOCKETS

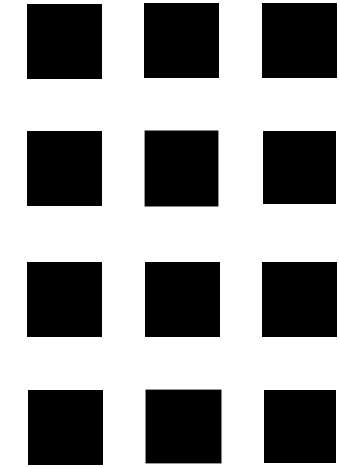

| | | | |
|--|---|--|--|
| <p>Product Code</p> <p>Fetaures</p> <p>Length</p> <p>Color</p> | <p>QTLU050 WH / GR / BK</p> <p>500mm Surface mount Track with Hand Wave sensor operated under light and Inbuilt 30W Fast USB A+C Type Charger.</p> <p>500mm (0.5mtr)</p> <p>WHITE/ GREY/ BLACK</p> | <p>QTLU100 WH / GR/ BK</p> <p>1000mm Surface mount Track with Hand Wave sensor operated under light and Inbuilt 30W Fast USB A+C Type Charger.</p> <p>1000mm (1.0mtr)</p> <p>WHITE/ GREY/ BLACK</p> | <p>QTLUS13- WH / GR/ BK</p> <p>Round Shaped Universal Power Adaptor with LED indicator. Twist to turn ON and OFF.</p> <p>NA</p> <p>WHITE/ GREY/ BLACK</p> |
|--|---|--|--|

SURFACE MOUNT
HOLLOW POWER TRACK

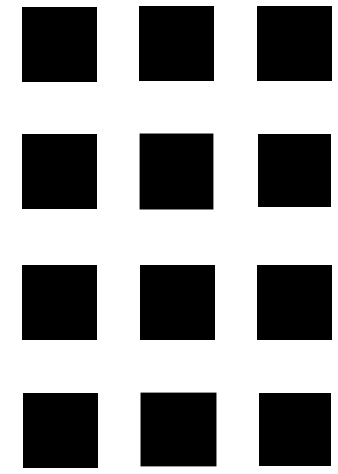

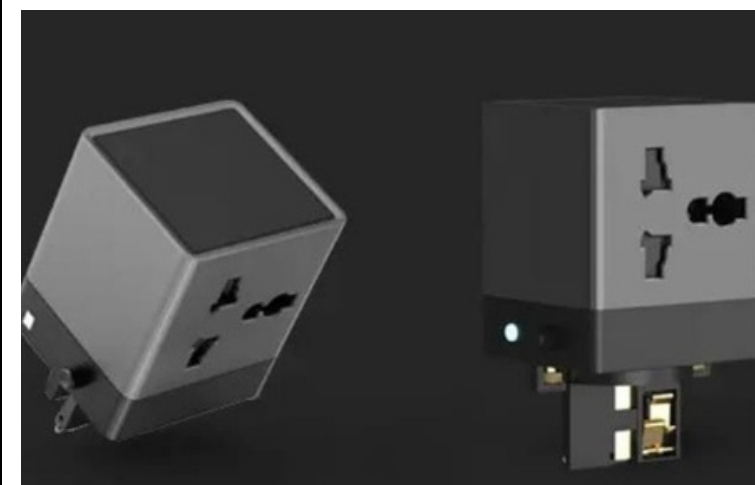
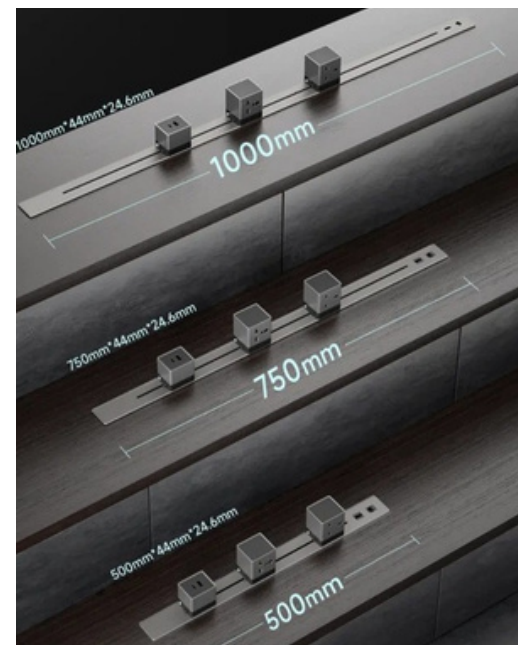
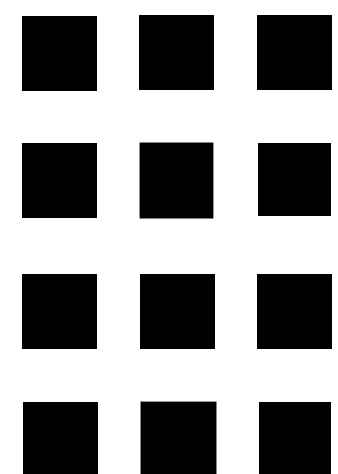
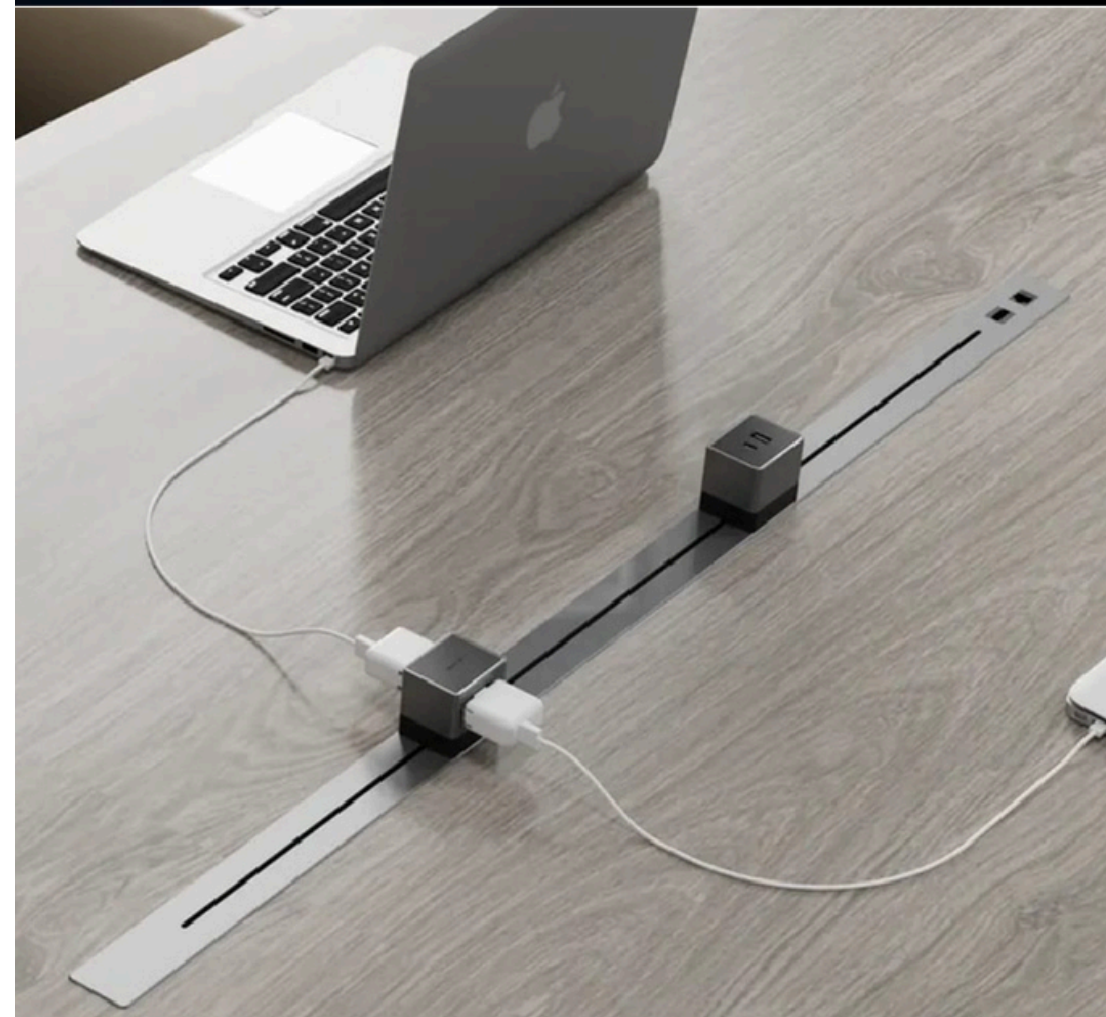
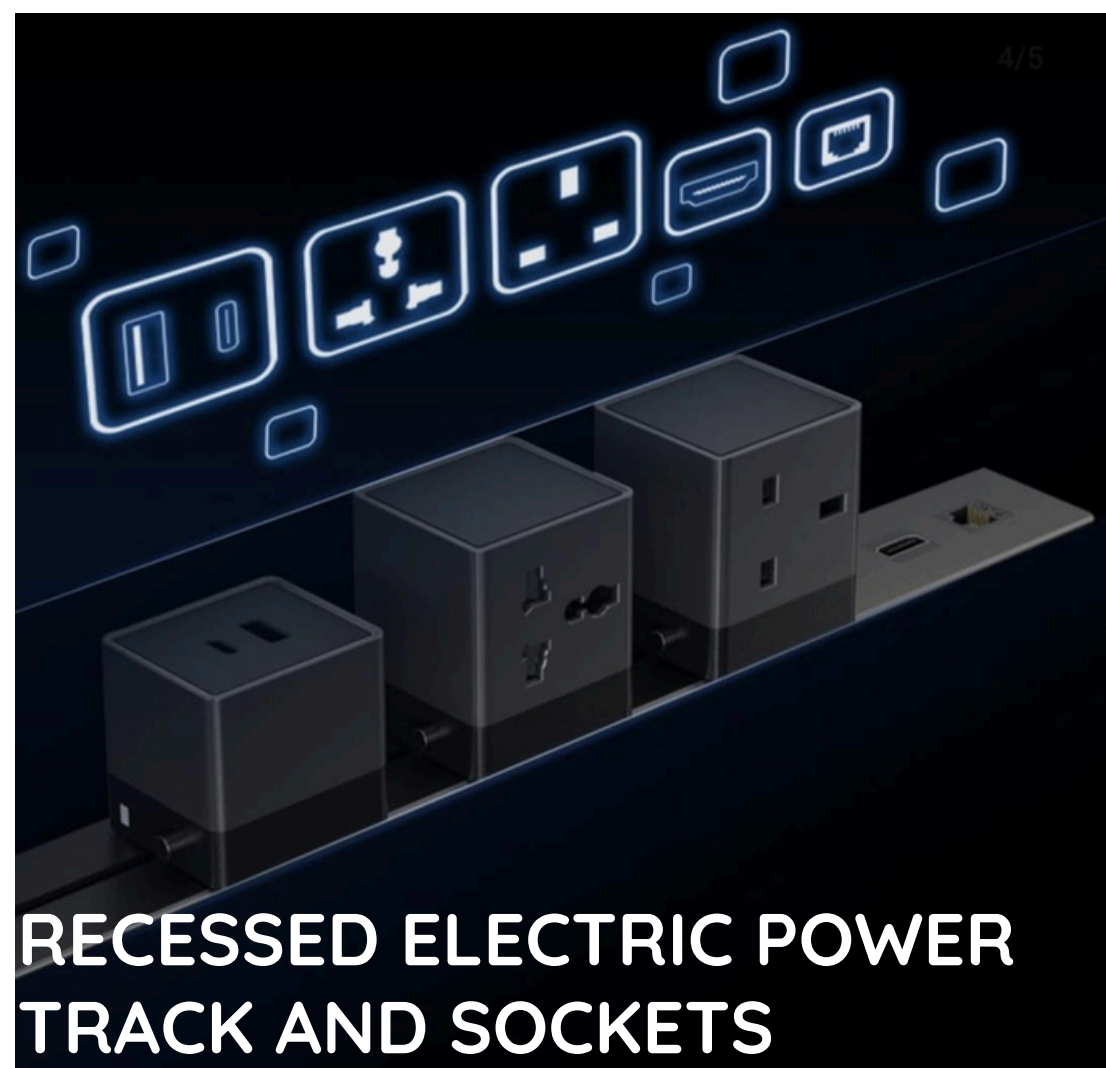

| | | | |
|----------------------------|---|--|--|
| <p>Product Code</p> | <p>QSCTR050 QSCTR075 QSCTR100</p> | <p>QSCTR213</p> | <p>QSCTRUSB</p> |
| <p>Features</p> | <p>Recessed Slim power track meeter grey finish with 1x cat6, 1x HDMI and 1.8M power cord plug and play Design.</p> | <p>Rectangular Shaped power adaptor with 2 x Universal sockets on each. Push Down to connect and press side buttons to release and move.</p> | <p>Rectangular Shaped power adaptor with USB Charger A+C Type on Top. Push Down to connect and press side buttons to release and move.</p> |
| <p>Length</p> | <p>0.5MTR (500mm) 0.75MTR (750mm) 1.0MTR (1000mm)</p> | <p>60*45mm</p> | <p>48*50mm</p> |
| <p>Color</p> | <p>GREY</p> | <p>GREY</p> | <p>GREY</p> |

RECESS SLEEK POWER TRACK AND SOCKETS

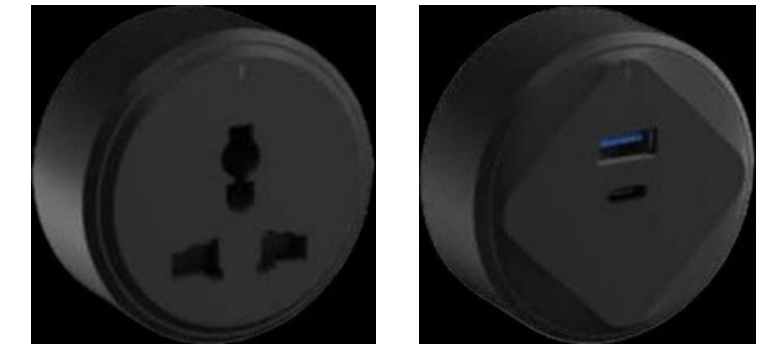
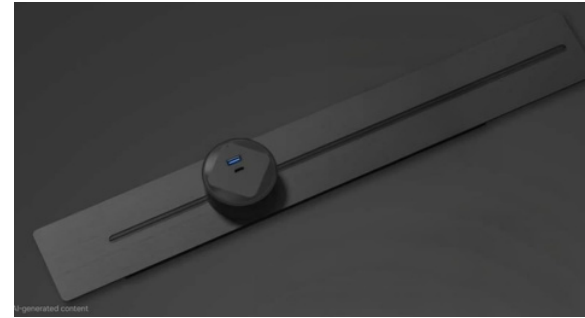
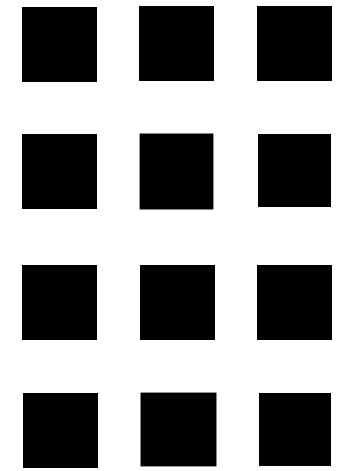

| | | | |
|----------------------------|--|--|---|
| | | | |
| <p>Product Code</p> | <p>QCTRN100 BK</p> | <p>QCTRNW100 BK</p> | <p>QCTRN13 QCTRNU</p> |
| <p>Features</p> | <p>Recessed Hairline Brush Finish Power track is easy to install also which gives flexibility to use as many desired sockets and USB chargers.</p> | <p>Recessed Hairline Brush Finish Power track is easy to install also which gives flexibility to use as many desired sockets and USB chargers with CAT6 and HDMI integrated.</p> | <p>Matt Black finish high Quality premium finish power adaptors Adaptor Universal socket Adaptor USB Charger A+C fast charge.</p> |
| <p>Length</p> | <p>1.0 MTR (1000mm)</p> | <p>1.0MTR (1000MM)</p> | |
| <p>Color</p> | <p>BLACK</p> | <p>BLACK</p> | <p>BLACK</p> |



RECESSED ELECTRIC POWER TRACK AND SOCKETS

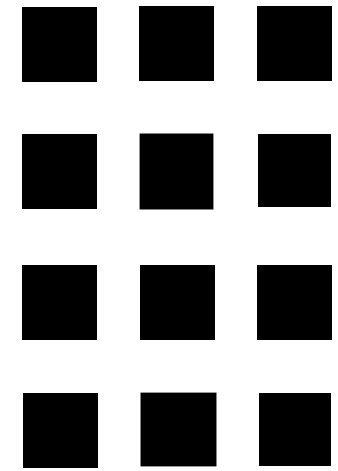

| | | | |
|----------------------------|--|---|--|
| | | | |
| <p>Product Code</p> | <p>QCTR750 QCTR100 QCTR150</p> | <p>QCTR613</p> | <p>QCTR613C</p> |
| <p>Features</p> | <p>Recessed power track with hairline with various weak power integration with like HDMI, CAT6, CAT3, USB, etc</p> | <p>Round Shaped power adaptor with Universal socket on top. Round turn to power on design with led indicator and aluminium ring Design.</p> | <p>Round Shaped power adaptor with Universal socket on top. Round turn to power on design with aluminum ring design cover.</p> |
| <p>Length</p> | <p>0.75MTR (750mm) 1.0MTR (1000mm) 1.5MTR (1500mm)</p> | <p>60*45mm</p> | <p>48*50mm</p> |
| <p>Color</p> | <p>SILVER/ BLACK</p> | <p>SILVER/ BLACK</p> | <p>SILVER/ BLACK</p> |

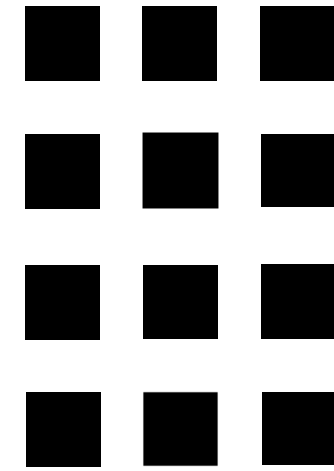

| | | |
|----------------------|---|---|
| |  |  |
| Product Code | QFB25012 | QFB34016 |
| Features | Screened floor box provides adaptable power, data, audio and video distribution in screen floors. | Screened floor box provides adaptable power, data, audio and video distribution in screen floors. |
| Configuration | 12m | 16m |
| Installation | Office / Malls/ Data centres | Office / Malls/ Data centres |

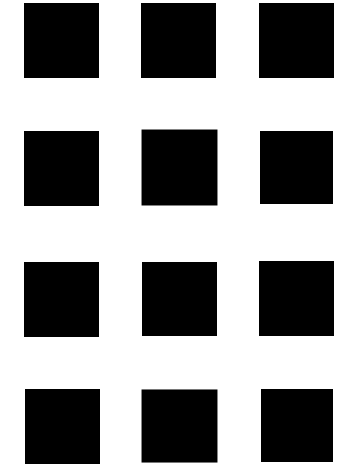
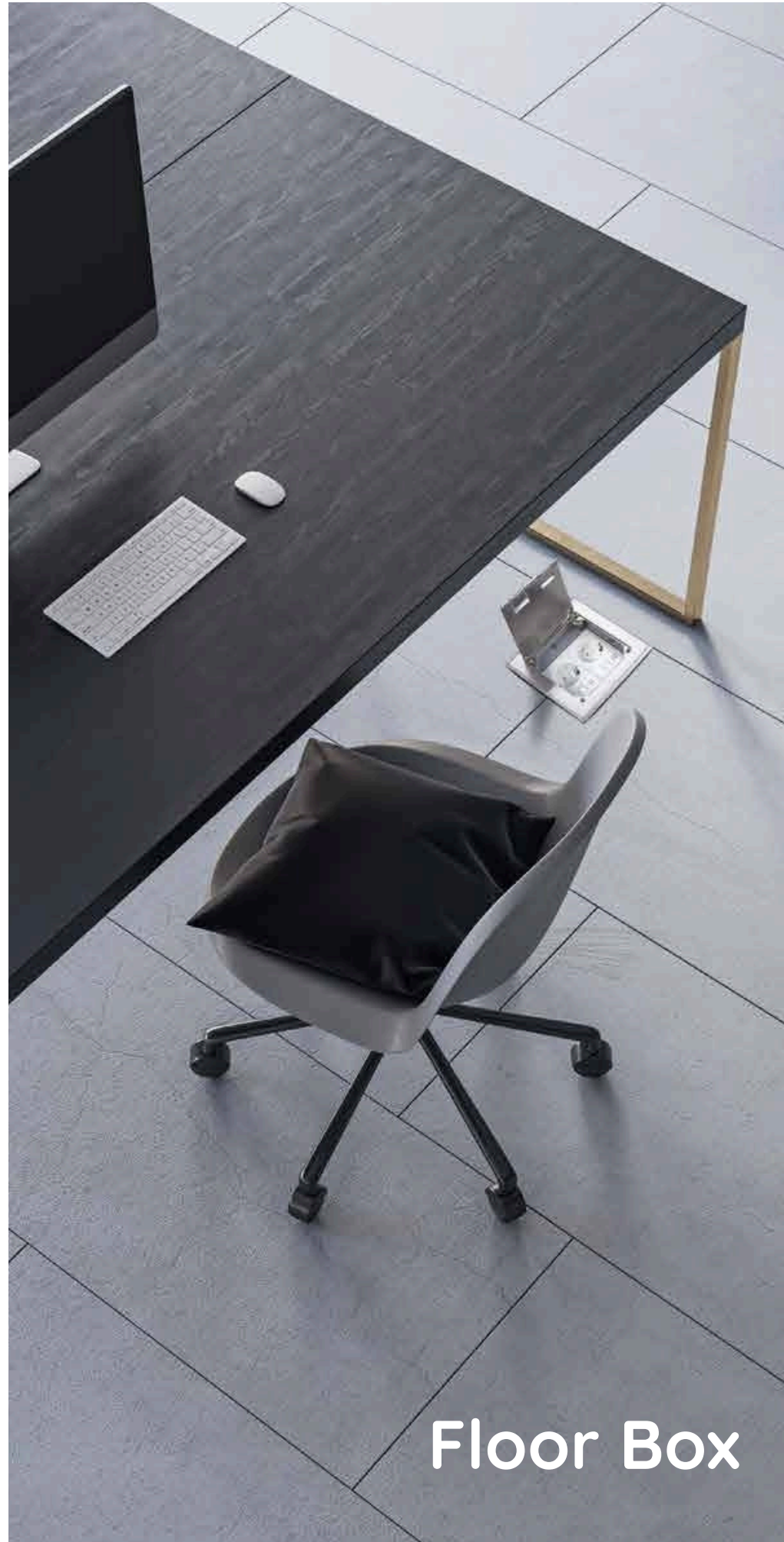



| | | | |
|----------------------|---|---|---|
| |  |  |  |
| Product Code | QFP1203 | QFP1466 | QFP18010 |
| Features | Stainless steel surface Module capacity-3 application : concrete/raised floor | Stainless steel surface Module capacity-6 application : concrete/raised floor | Stainless steel surface Module capacity-10 application : concrete/raised floor |
| Configuration | Top cover size : 120x120x4 mm (thick) Cut out size : 112x112x75 mm (depth) | Top cover size : 146x146x4 mm (thick) Cut out size : 138x138x75 mm (depth) | Top cover size : 180x180x4 mm (thick) Cut out size : 172x172x75 mm (depth) |
| Installation | Office / Malls/ Data centres | Office / Malls/ Data centres | Office / Malls/ Data centres |

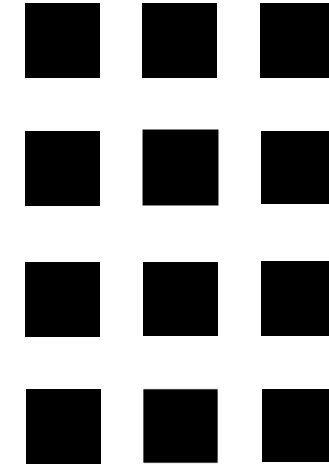

Floor Box



| | | |
|--|---|---|
|  |  | |
| <p>Product Code</p> <p>Features</p> <p>Configuration</p> <p>Installation</p> | <p>QFP21015</p> <p>Stainless steel surface Module capacity-15 application : concrete/raised floor</p> <p>Top cover size : 125x125x19 mm (thick) Cut out size : 125x125x70 mm (depth)</p> <p>Office / Malls/ Data centres</p> | <p>QFPT1304</p> <p>Stainless steel surface with 16mm depth for Tile/ Carpet/ Marble mount. Module capacity 4M</p> <p>Top cover size : 130x130x19 mm (thick) Cut out size : 130x130x90 mm (depth)</p> <p>Office / Malls/ Data centres</p> |

FLAT DESIGN HIDDEN STAINLESS STEEL FLOOR SOCKET

65mm Ultra thin box installation box

Flat design Embedded Floor Ultra thin box Widely applicable #304 Stainless Steel Panel Compression & wear resistance Security Guard Electricity Safety

Floor Box

| | | | |
|--|--|---|---|
| | | | |
| <p>Product Code</p> <p>Fetaures</p> <p>Configuration</p> <p>Installation</p> | <p>QFPT13806</p> <p>Stainless steel surface with 16mm depth for Tile/ Carpet/ Marble mount. Module capacity 6M</p> <p>Top cover size : 146x146x19 mm (thick) Cut out size : 146x146x90 mm (depth)</p> <p>Office / Malls/ Data centres</p> | <p>QFPT17210</p> <p>Stainless steel surface with 16mm depth for Tile/ Carpet/ Marble mount. Module capacity 10M</p> <p>Top cover size : 172x172x19 mm (thick) Cut out size : 172x172x90 mm (depth)</p> <p>Office / Malls/ Data centres</p> | <p>QFPT20215</p> <p>Stainless steel surface with 16mm depth for Tile/ Carpet/ Marble mount. Module capacity 15M</p> <p>Top cover size : 210x210x19 mm (thick) Cut out size : 210x210x90 mm (depth)</p> <p>Office / Malls/ Data centres</p> |



Waterproof IP66 Floor Box

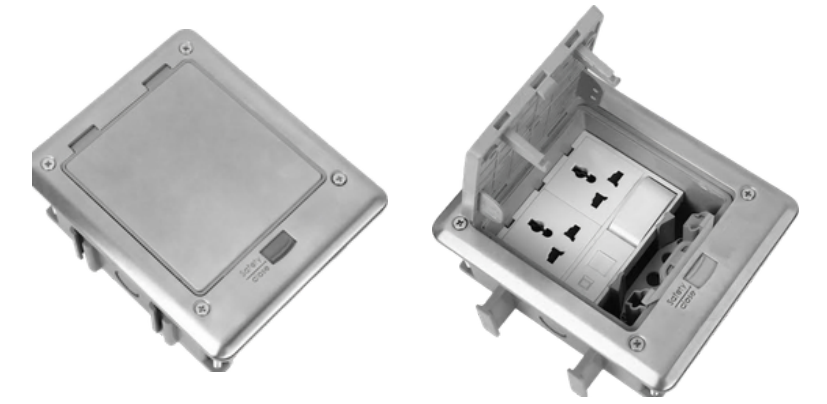
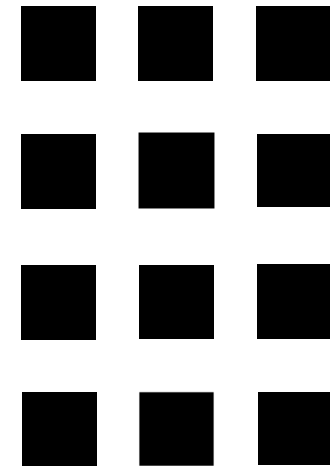

| | | |
|----------------------|---|---|
| | | |
| Product Code | QWPF03 | QWPF06 |
| Features | <ul style="list-style-type: none"> - Stainless steel surface - Ip66 (In closed position) - Gangable Installation - Weight capacity 800kg - Two Opening position. | <ul style="list-style-type: none"> - Stainless steel surface - Ip66 (In closed position) - Gangable Installation - Weight capacity 800kg - Two Opening position. |
| Configuration | <p>Top cover size : 120x135x19 mm Modulecapacity-3</p> | <p>Top cover size : 120x135x19 mm Modulecapacity-6</p> |
| Installation | Malls/ Office / Outdoor Lobby | Malls/ Office / Outdoor Lobby |

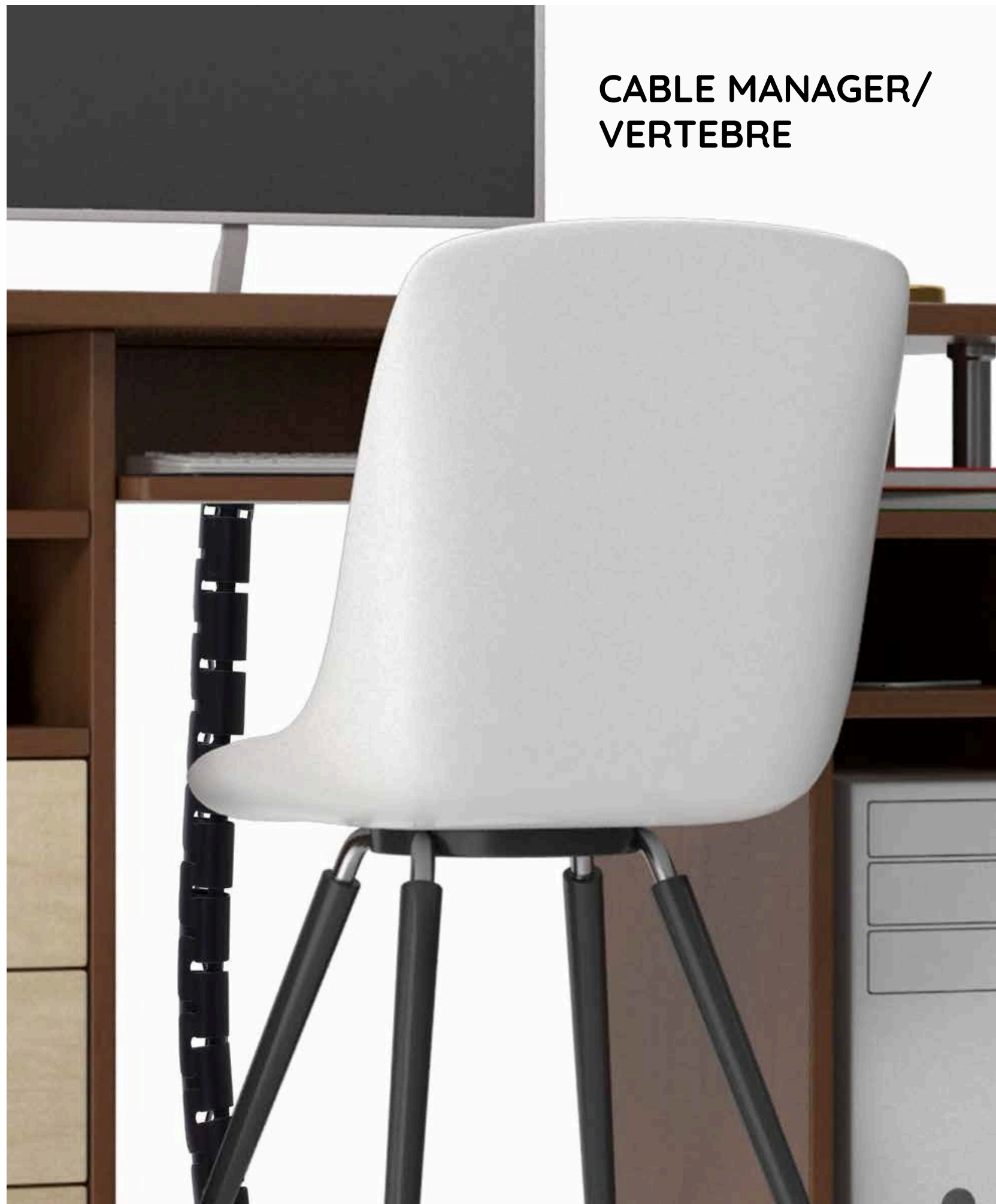

**CABLE MANAGER/
VERTEBRE**

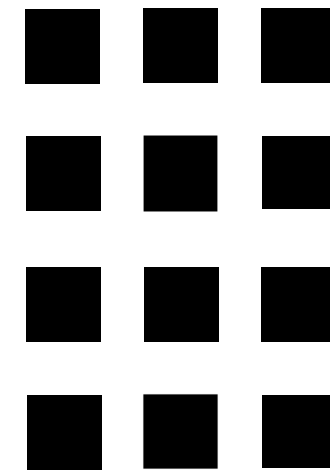

| | | |
|---------------------|---|---|
| |  |  |
| Product Code | QWM32 WH/ GR /BK | QWM32 WH/ GR /BK |
| Size | 32mm | 32mm |
| Length | 1.5 mtr | 1.5 mtr |
| Features | | |

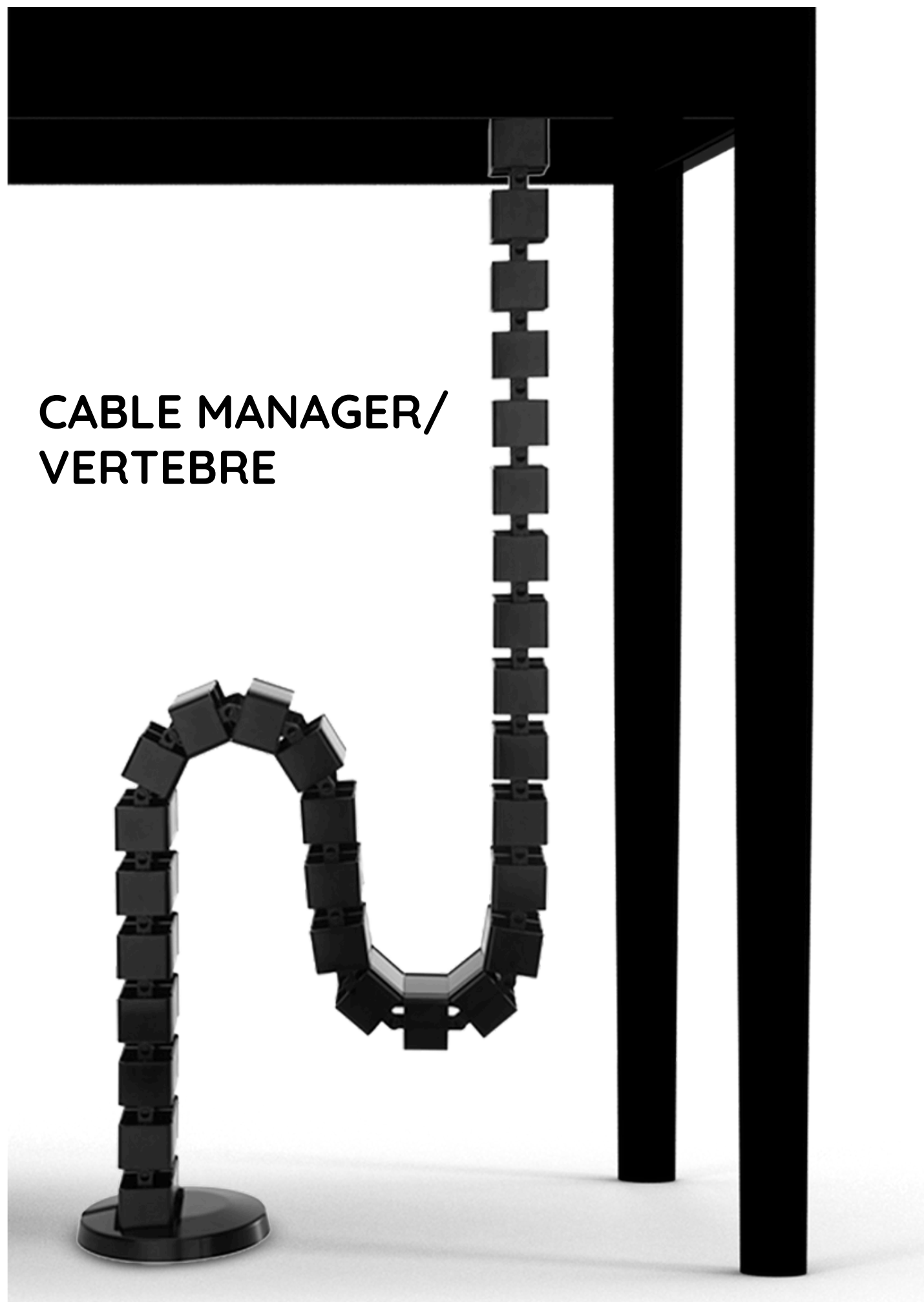

**CABLE MANAGER/
VERTEBRE**

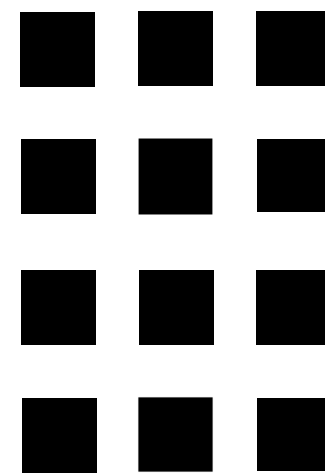

| | | |
|---------------------|---|--|
| Product Code | QWM5025 WH/ SL / BK | QWM5050WH/ SL / BK |
| Size | 50mmX 25mm | 50mmX 25mm |
| Length | 780 mm | 780 mm |
| Features | Square Shaped Cable vertebre helps to hide all your wires from floor to tablet inside it. Length can be adjusted. | Round Shaped Cable vertebre helps to hide all your wires from floor to tablet inside it. Length can be adjusted. |

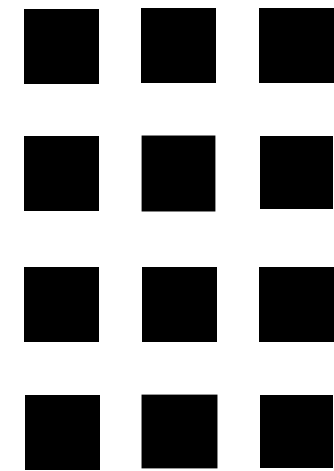



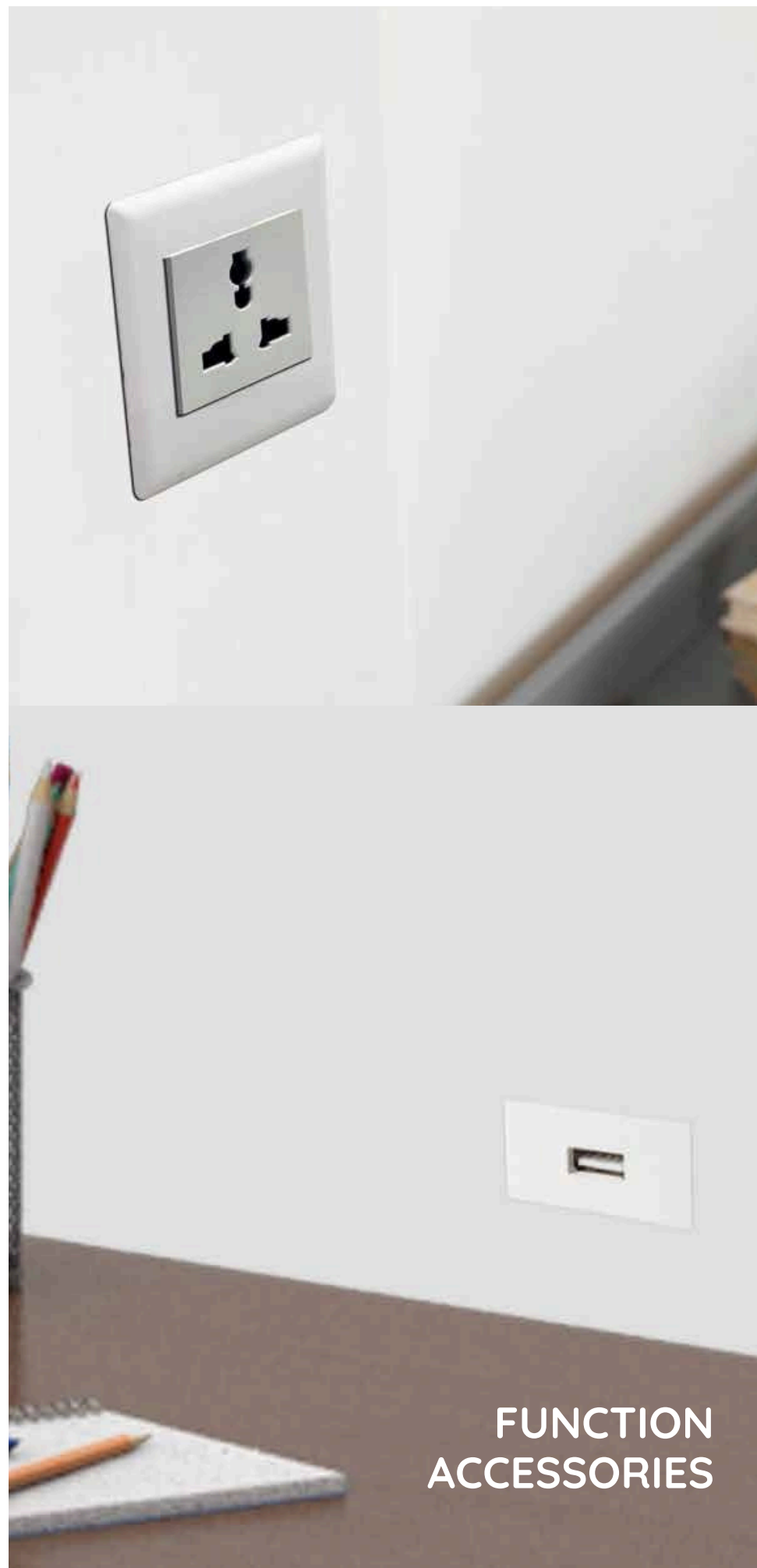

| | | | | |
|-----------------------|-----------------------------|--|--|----------------|
| | | | | |
| Product Code | QWPO1 | QF01 | QF02 | QF03 |
| No. of modules | 2 | 1 | 1 | 1 |
| Description | IP55 waterproof bell switch | 10AMP 1way switch with rounded borders | HDMI socket female to female with wire | VGA socket F2F |

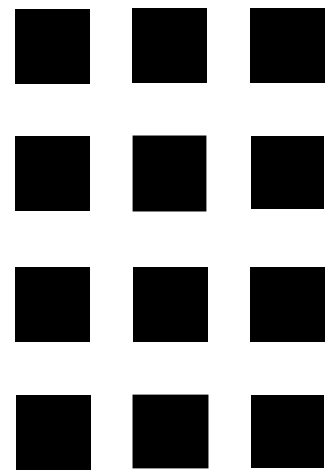

**FUNCTION
ACCESSORIES**



| | | | | |
|-----------------------|---|---|---|---|
| |  |  |  |  |
| Product Code | QF04 | QF04 | QF05 | QF28 |
| No. of modules | 1 | 1 | 1 | 2 |
| Description | USB DATA F2F | AUDIO JACK | HDMI FEMALE TO FEMALE WITH 12" WIRE | 6/13A UNIVERSAL SOCKETS |

**FUNCTION
ACCESSORIES**

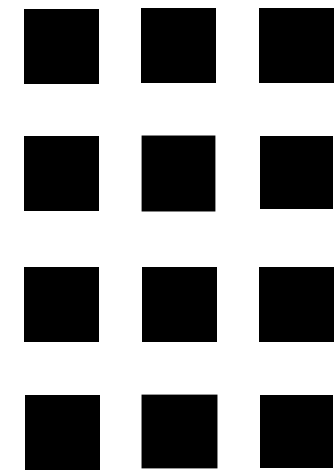

| | | | | |
|-----------------------|------------------------------|------------------------------|------------------------------|------------------------------|
| Product Code | OF12 WH | QF12 BK | QF22-65 B | QF22-65 W |
| No. of modules | 1 | 1 | 1 | 1 |
| Description | 20W 1M A+C USB CHARGER WHITE | 20W 1M A+C USB CHARGER BLACK | 65W PD A+C USB CHARGER BLACK | 65W PD A+C USB CHARGER WHITE |

**FUNCTION
ACCESSORIES**

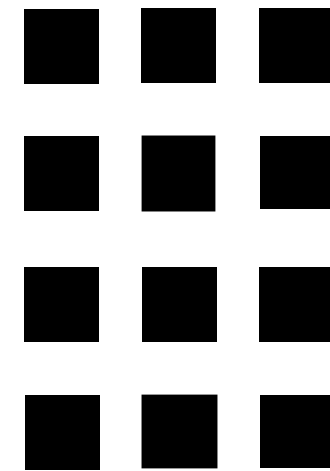

| | | | | |
|-----------------------|------------------------------|---|---|---|
| | |  |  |  |
| Product Code | OF12 WH | QF12 BK | QF22-65 B | QF22-65 W |
| No. of modules | 1 | 1 | 1 | 1 |
| Description | 20W 1M A+C USB CHARGER WHITE | 20W 1M A+C USB CHARGER BLACK | 65W PD A+C USB CHARGER BLACK | 65W PD A+C USB CHARGER WHITE |

Divya Electricals

Chennai

Contact:

9841260168

96009984212

044-4216 5795

divyaelectricalschennai@yahoo.co.in