

# LUXURIA



## ENABLING BRIGHT IDEAS

# Linear Lighting Application

## SCENCE

- 1 Hotel
- 2 Residential
- 3 Office
- 4 Retail
- 5 Gym&Spa
- 6 Theater & Museum
- 7 Garden Landscaping
- 8 Station Hall
- 9 Maritime
- 10 Under Water
- 11 Outdoor
- 12 Contour Lighting



## INDOOR & OUTDOOR

- 1 Contour Lighting
- 2 Under Eave Lighting
- 3 Indoor Lighting
- 4 Wall Wash Lighting
- 5 Facade Grazing Light-Downwards
- 6 Facade Grazing Light-Upwards
- 7 Step, Stairs
- 8 Under Beach
- 9 Waterside

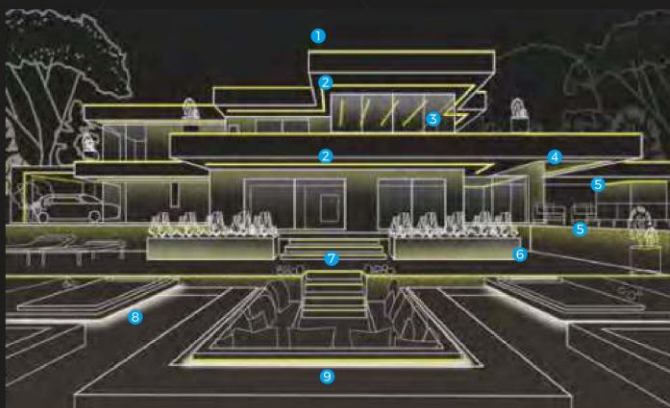

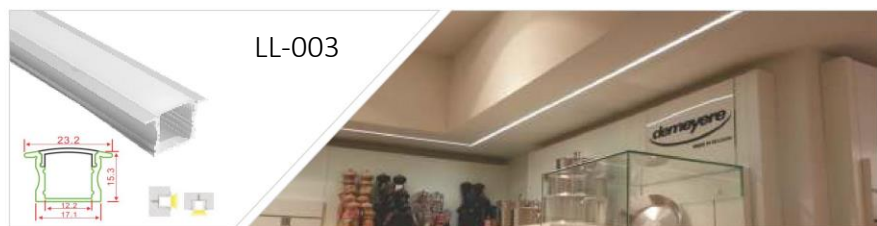
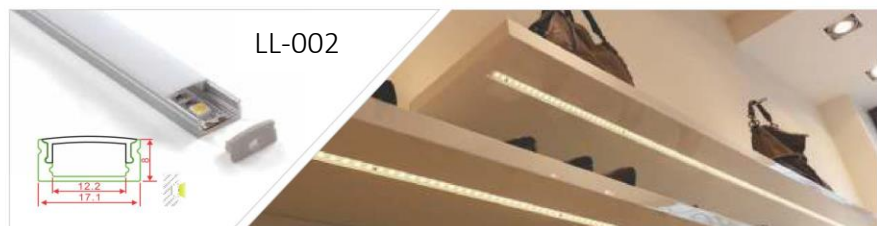
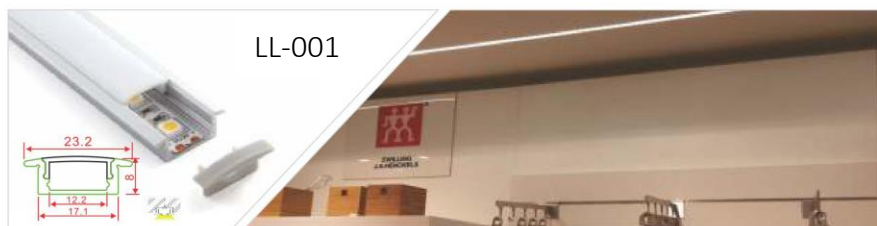

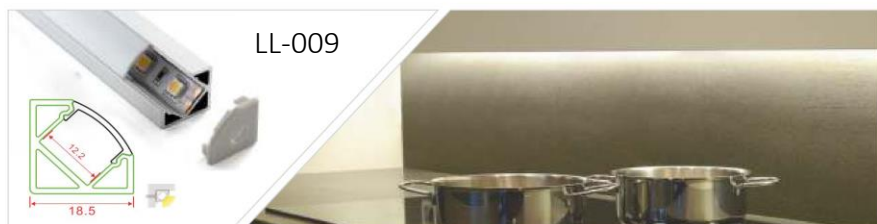

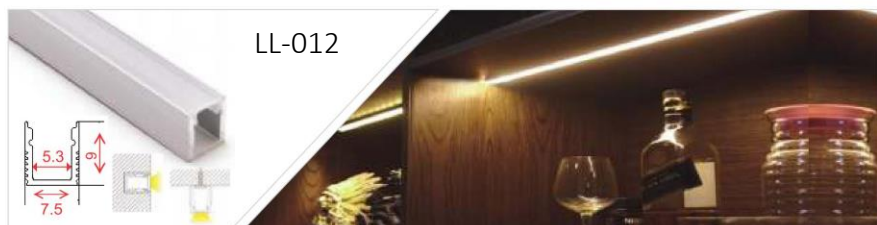
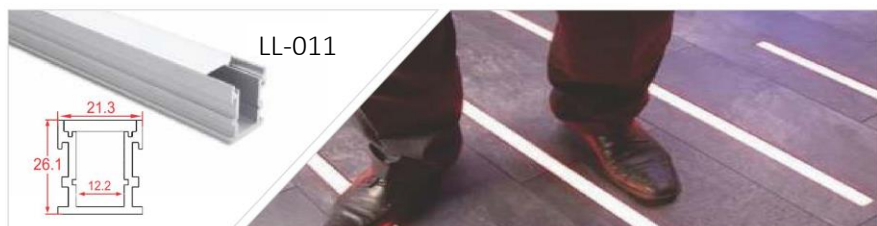

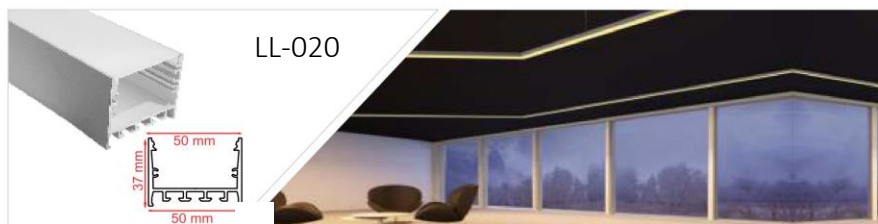
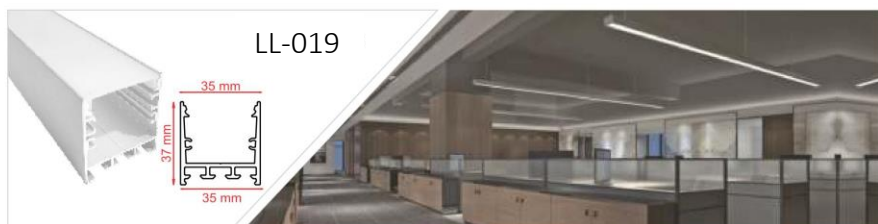
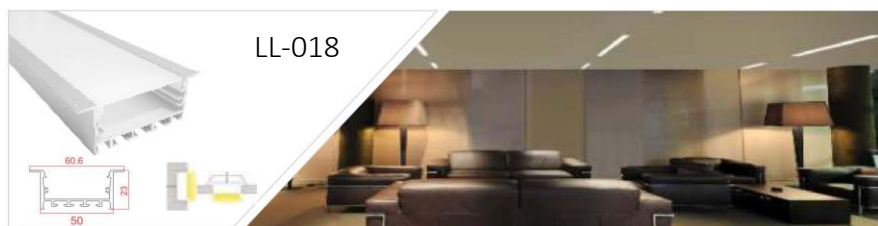
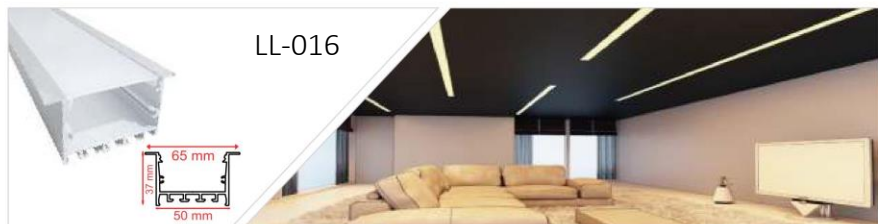



LL-021

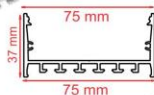

LL-022



LL-023

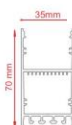

LL-024

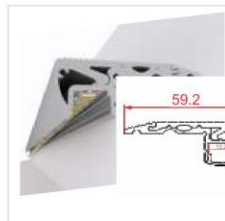
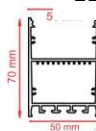

LL-025



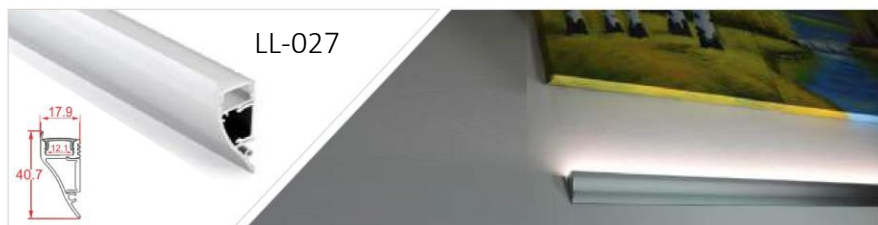

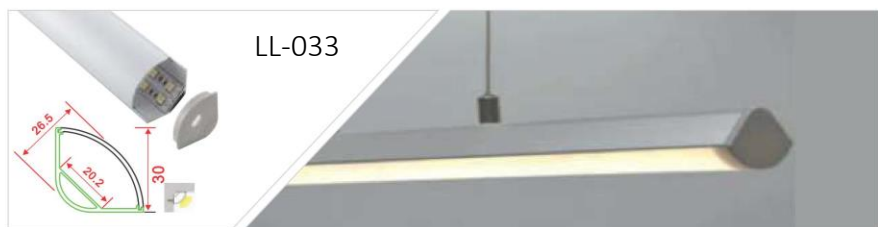

LL-036



CORNER LENS PROFILL



LL-037



LL-038

LL-039



FLOORING PROFILE



LL-040



WALL WASHER PROFILE

ASYMMETRIC LIGHTING



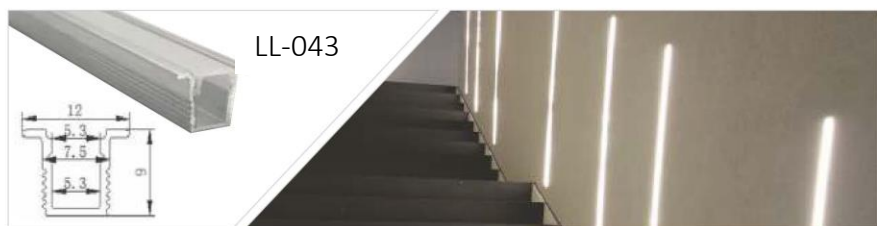
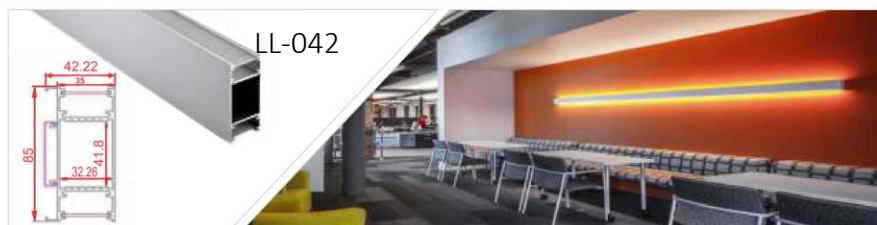



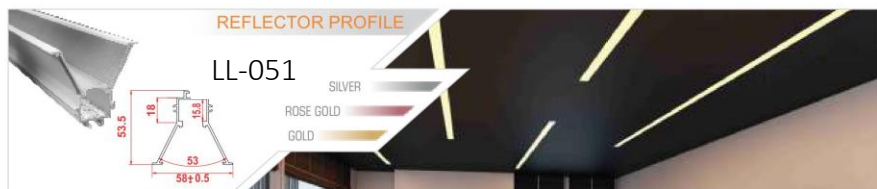





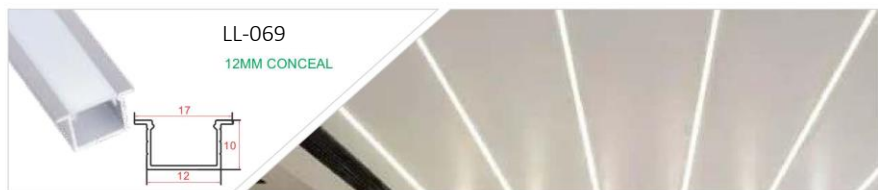

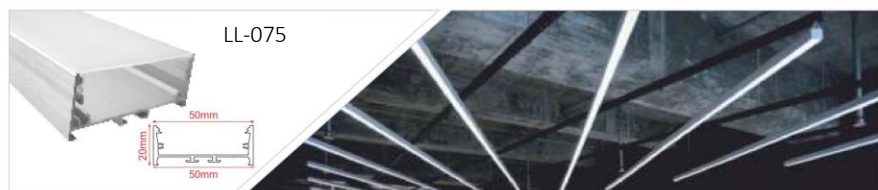
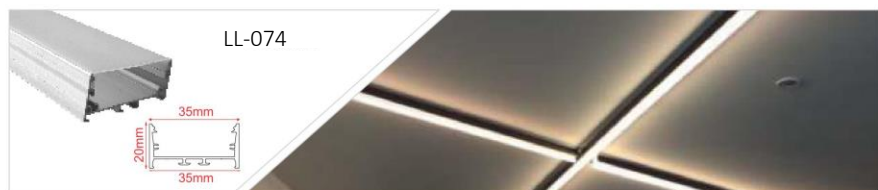





# CLEAR COVER

## LED ALUMINIUM PROFILE



# 25MTR ROLL FORM

LONG RUN DIFFUSER



• 50MM

• 35MM

(25MTR) ROLL FORM



### TRIMELESS SERIES

This series products fully integrated architectural lighting, it offers unprecedented visual possibilities through Invisible line. The profiles can be easily integrated at a minimum installation depth of only 10 mm. The almost infinite three-dimensional matching combinations offer unprecedented freedom to satisfy all creative ambitions.

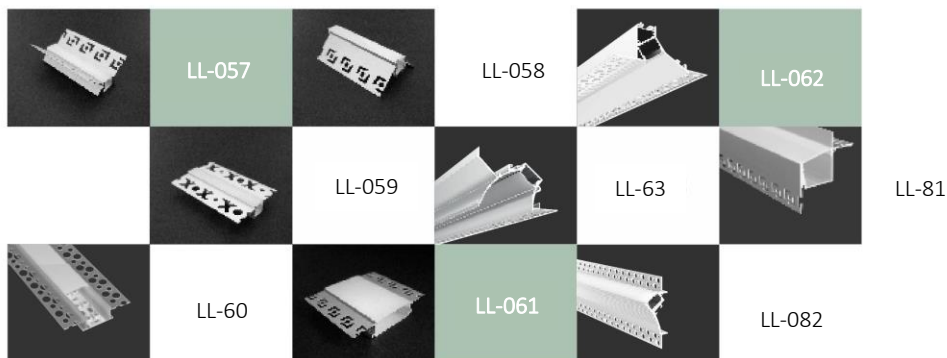

### Recessed into Drywall Trimless Profile

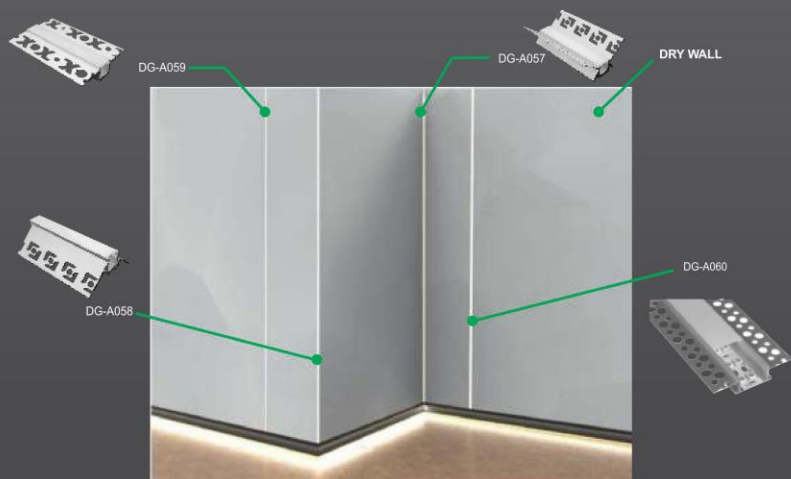

# TRIMELESS SERIES

LUXURIA

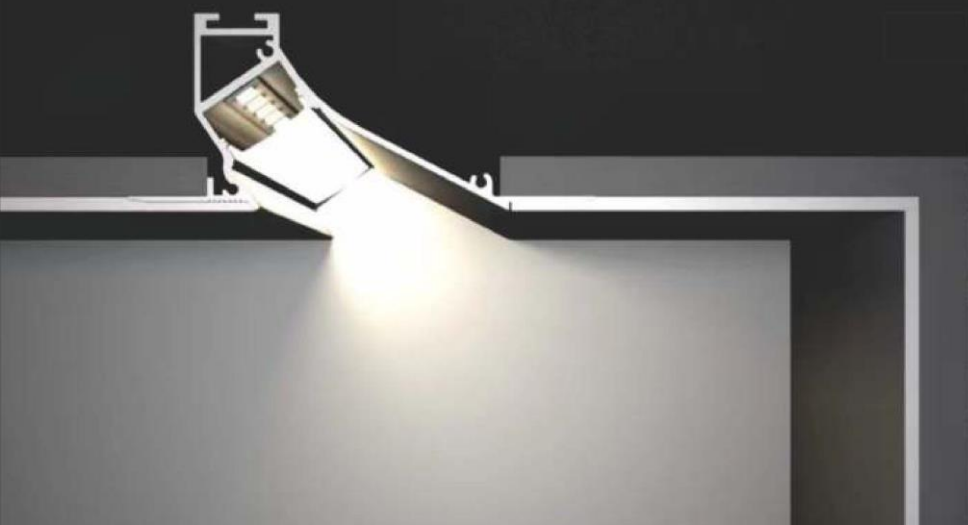

LL-062

WALLWASHER GYPSUM PLASTER  
LED ALUMINIUM PROFILE

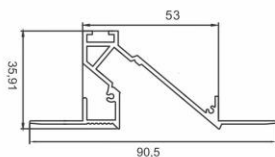
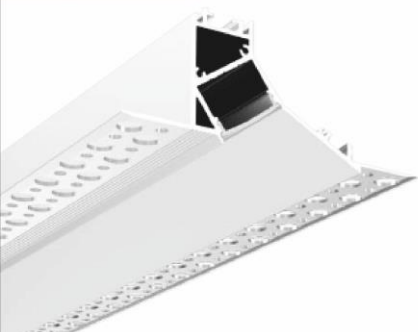

Check the Recessed Aluminium LED Channels, the inner width is 18,7mm and compatible double rows 2835 or 3528 Mini LED Strips, can be recessed into the drywall or plasterboard for the architectural lighting in the offices,

shops, schools, factories, etc. the standard length is 1meter, the max length is 3meter per piece and cuttable, you can cut to any size for your project, the 90°, inside 90° and 180° connector sold separately for your lighting project. there are two types of diffusers available, the



PC diffused cover and PC semi-clear cover, both of them made of brand stable material, anti-yellowing, perfect light distribution and smooth light output. the Wall Washer LED Channel made of 6063-T5 aluminum alloy and silver anodized surface treatment, anti-oxidation resistance and has a longer lifespan than other similar products. the end caps with wire holes included, easy to connect the Mini LED Strips. The PWM Dimmable Driver to light up or adjust the brightness. the inclined lighting can be used as wall washer lighting for interior lighting design.

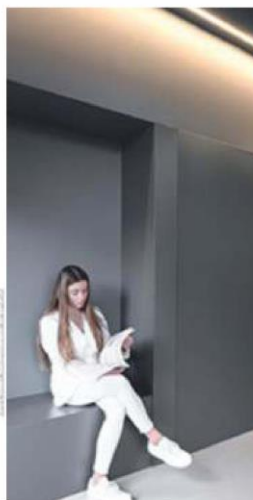
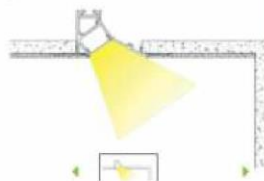

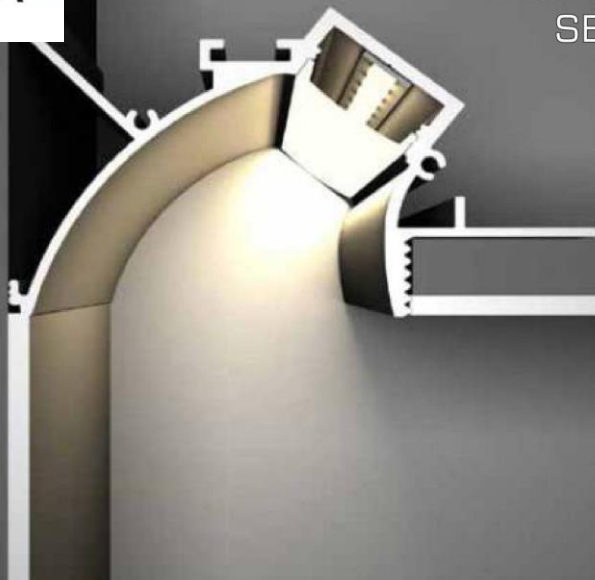

LL-063

WALLWASHER GYPSUM PLASTER  
LED ALUMINIUM PROFILE

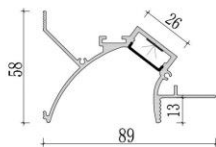

Check the Recessed Aluminium LED Channels, the inner width is 18.7mm and compatible double rows 2835 or 3528 Mini LED Strips, can be recessed into the drywall or plasterboard for the architectural lighting in the offices,

shops, schools, factories, etc. the standard length is 1meter, the max length is 3meter per piece and cuttable, you can cut to any size for your project, the 90°, inside 90° and 180° connector sold separately for your lighting project. there are two types of diffusers available, the



PC diffused cover and PC semi-clear cover, both of them made of brand stable material, anti-yellowing, perfect light distribution and smooth light output. the Wall Washer LED Channel made of 6063-T5 aluminum alloy and silver anodized surface treatment, anti-oxidation resistance and has a longer lifespan than other similar products. the end caps with wire holes included, easy to connect the Mini LED Strip. The PWM Dimmable Driver to light up or adjust the brightness. the inclined lighting can be used as wall washer lighting for interior lighting design.

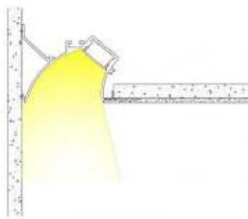



LL-082

WALLWASHER GYPSUM PLASTER  
LED ALUMINIUM PROFILE



Check the Recessed Aluminium LED Channels, the inner width is 18.7mm and compatible double rows 2835 or 3528 Mini LED Strips, can be recessed into the drywall or plasterboard for the architectural lighting in the offices,

shops, schools, factories, etc. the standard length is 1meter; the max length is 3meter per piece and cuttable, you can cut to any size for your project, the 90°, inside 90° and 180° connector sold separately for your lighting project. there are two types of diffusers available, the



PC diffused cover and PC semi-clear cover, both of them made of brand stable material, anti-yellowing, perfect light distribution and smooth light output. The Wall Washer LED Channel made of 6063-T5 aluminum alloy and silver anodized surface treatment, anti-oxidation resistance and has a longer lifespan than other similar products. the end caps with wire holes included, easy to connect the Mini LED Strip. The PWM Dimmable Driver to light up or adjust the brightness. the inclined light washer lighting for interior lighting design.



# WATERPROOF LED ALUMINIUM PROFILE

LL-047

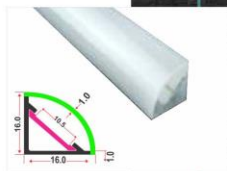

IP 65 Water Resistant Channel

A Fully plastic water resistant channel ideal for being mounted outdoors and in damp environments. This extrusions is a revolutionary design allowing the user to install in damp environments without water ingress. The tape sits on a metal insert inside. due to the nature of this product it is advised that you don't use a tape over 14watts per meter because of the reduced heat sync.

LL-048

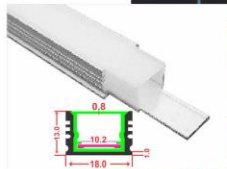

Waterproof led aluminum profiles are widely used for most field. The channels can be cut down to any length. LED strips not including. Fits most popular LED strip types. 10mm inner width accepts PCB width up to 12mm LED Strips, such as 3528, 5050, 2835 LED strips(Normally type), Simply stick the LED strip light's adhesive backing inside the aluminum channel, snap on the diffuser cover. Achieve under-cabinet and back splash lighting, accent and back lighting with ease. Light up your living room, bedroom, closet, kitchen, patio, under stairs, exhibits, furniture, work stations, etc. And it is very easy installation...

# WALK & DRIVE OVER WATERPROOF PROFILES

LL-WDO-H

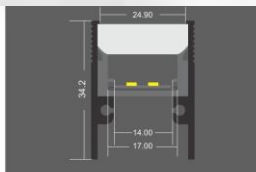

LL-WDO-C

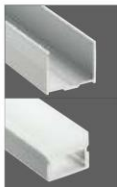
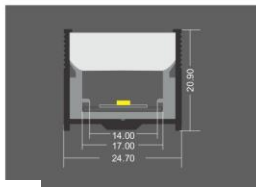



## FLEXI GRAZER

### LIGHTING OPTIONS

Single Colour 2400K-6000K  
Dual Colour  
RGBW  
Pixel Addressable

### DIMENSIONS

Profile Encapsulated 37 x 30mm  
Linear 18,5x 9.5mm  
Asymmetric 18.5 x 9.6mm

### FEATURES

UV Resistant  
Salt Water Resistant  
IP67  
Solvent Resistant  
Flame Resistant

### BEAM ANGLE

Profile Encapsulated 20°/ 30°  
Linear 45° x 20°  
Asymmetric 120°



THIS LATEST ADDITION TO OUR RANGE OF CONTEMPORARY LIGHTING SOLUTIONS IS IDEAL FOR ACHIEVING A FLAWLESS WALL WASHING EFFECT.

Focused and directional, the Flexi Grazer is silicone encapsulation ensures durability, available in various single and dual beam reliability and ease of installation.

angles suitable for different environments. The luminaire is available in single colour While the lens implanted the LED temperature ranging from 2400K to 6000K,

# LED LASER BLADE PROFILE

LUXURIA

## SUSPENDABLE LASER BLADE LED PROFILE



## RECESSED LASER BLADE LED PROFILE

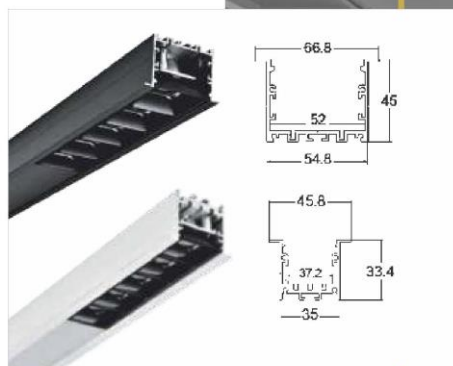

# ROUND RING

LED ALUMINIUM PROFILE



Diameter : 600mm or 900mm or 1200mm



LIGHT OFF

LUXURIA

BLACK SERIES  
LED ALUMINIUM PROFILE

LIGHT ON

BLACK WITH BLACK DIFFUSER

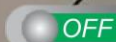

LL-BK-001



LL-BK-008



LL-BK-002



LL-BK-009



LL-BK-003



LL-BK-010



LL-BK-004

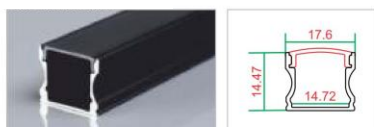

LL-BK-044



LL-BK-005



LL-BK-012



LL-BK-006



LL-BK-043



BLACK WITH BLACK DIFFUSER



LL-BK-013

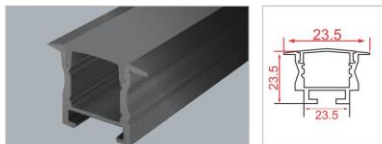

LL-BK-020

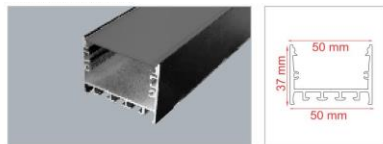

LL-BK-015



LL-BK-023

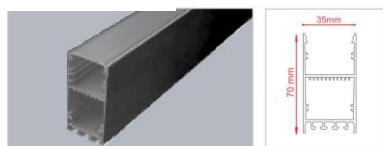

LL-BK-016

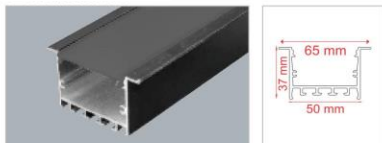

LL-BK-024

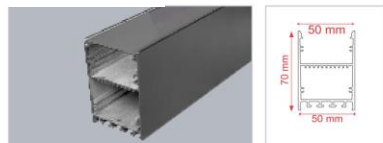

LL-BK-018

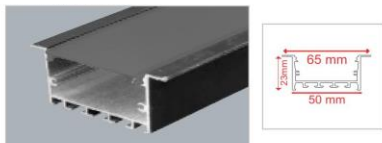

LL-BK-078



LL-BK-019

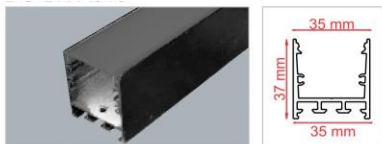

LL-BK-077



BLACK WITH BLACK DIFFUSER

# GEOMETRICAL SHAPE PROFILE

## ROUND HANGING PROFILE

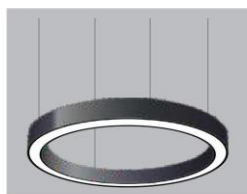

ITEM	SIZE	WATT	COLOR TEMP
LL-RD-01-450MM - DONUT	L450 x W80 x H70	36W	3K / 4K / 6K
LL-RD-02-600MM - DONUT	L600 x W80 x H70	48W	3K / 4K / 6K
LL-RD-03-900MM - DONUT	L900 x W80 x H70	72W	3K / 4K / 6K
LL-RD-04-1200MM-DONUT	L1200 x W80 x H70	96W	3K / 4K / 6K



ITEM	SIZE	WATT	COLOR TEMP
LL-RD-05-450MM - DRUM	L450 x W80 x H70	36W	3K / 4K / 6K
LL-RD-06-600MM - DRUM	L600 x W80 x H70	48W	3K / 4K / 6K
LL-RD-07-900MM - DRUM	L900 x W80 x H70	72W	3K / 4K / 6K
LL-RD-08-1200MM - DRUM	L1200 x W80 x H70	96W	3K / 4K / 6K



# GEOMETRICAL SHAPE PROFILE

## HEXAGON HANGING PROFILE



ITEM	SIZE	WATT	COLOR TEMP
LL-HX-01-450MM - DONUT	L450 x W80 x H70	24W	3K / 4K / 6K
LL-HX-02-600MM - DONUT	L600 x W80 x H70	36W	3K / 4K / 6K
LL-HX-03-900MM - DONUT	L900 x W80 x H70	48W	3K / 4K / 6K
LL-HX-04-1200MM-DONUT	L1200 x W80 x H70	72W	3K / 4K / 6K



ITEM	SIZE	WATT	COLOR TEMP
LL-HX-05-450MM - DRUM	L450 x H70	36W	3K / 4K / 6K
LL-HX-06-600MM - DRUM	L600 x H70	48W	3K / 4K / 6K
LL-HX-07-900MM - DRUM	L900 x H70	72W	3K / 4K / 6K
LL-HX-08-1200MM - DRUM	L1200 X H70	72W	3K / 4K / 6K





# GEOMETRICAL SHAPE PROFILE

## TRIANGLE HANGING PROFILE



ITEM	SIZE	WATT	COLOR TEMP
LL-TRI-01-600MM - DONUT	L450 x W80 x H70	48W	3K / 4K / 6K

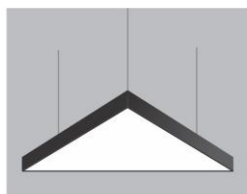

ITEM	SIZE	WATT	COLOR TEMP
LL-TRI-02-600MM - DRUM	L600 x H70	48W	3K / 4K / 6K



LL-BK-001

## LED STRIP

## FLEXIBLE LED STRIP LIGHT

## ● Design

Discover a new world of attractive accent lighting with Integral's latest LED strip range. For soft, stylish, coloured lighting in almost any area - indoor and outdoor - we have the ideal strip for your space. Choose from 8 new ranges with options to allow you to create:

- A seamless linear light effect
- Variable, remote-controlled colour schemes
- Flexible illumination for signage
- Fun and vibrant cascading effects

## ● Quality

Built to last, our comprehensive range of innovative strips offer excellent build quality, superior components and consistent light.

- Low energy
- Ingress protection up to IP65

LL-2835-204LED-(10MM) 12V

NEW



4k

3k



## Description

1. Made by 2835 Top LEDs with latest technology
2. Designed to consistent the current and voltage of strip from the front to the end which have only 5% current differences
3. Max. working length up to 5M by one end powered
4. thick 3oz PCB, heat transfer thermal tape, nice design package. LED with LM-80 Test approval.

Model No	LED Density	Color	Width	Work Voltage	Lumens	Peak Power
LL-2835-204LED-12V	204 leds/m	3K/4K	10MM	DC12V	950Lm	8w/m

-2835-120LED-(5MM) 12V/24V



6k

4k

3k



## Description

1. Made by 2835 Top LEDs with latest technology
2. Designed to consistent the current and voltage of strip from the front to the end which have only 5% current differences
3. Max. working length up to 5M by one end powered
4. thick 3oz PCB, heat transfer thermal tape, nice design package. LED with LM-80 Test approval.

Model No	LED Density	Color	Width	Work Voltage	Lumens	Peak Power
DG-2835-120LED-12V	120 leds/m	3K/4K/6K	8MM	DC12V	1750Lm	14.4 w/m
DG-2835-120LED-24V	120 leds/m	3K/4K/6K	8MM	DC24V	1750Lm	14.4 w/m

LL-2835-120LED-(8MM) 12V/24V



## Description

1. Made by 2835 Top LEDs with latest technology
2. Designed to consistent the current and voltage of strip from the front to the end which have only 5% current differences
3. Max. working length up to 5M by one end powered
4. thick 3oz PCB, heat transfer thermal tape, nice design package. LED with LM-80 Test approval.

Model No	LED Density	Color	Width	Work Voltage	Lumens	Peak Power
LL-2835-120LED-12V	120 leds/m	3K/4K/6K	8MM	DC12V	1750Lm	14.4 w/m
LL-2835-120LED-24V	120 leds/m	3K/4K/6K	8MM	DC24V	1750Lm	14.4 w/m

LL-2835-168LED-(10MM) 12V



## Description

1. Made by 2835 Top LEDs with latest technology
2. Designed to consistent the current and voltage of strip from the front to the end which have only 5% current differences
3. Max. working length up to 5M by one end powered
4. thick 3oz PCB, heat transfer thermal tape, nice design package. LED with LM-80 Test approval.

Model No	LED Density	Color	Width	Work Voltage	Lumens	Peak Power
DG-2835-168LED-12V	168 leds/m	3K/4K/6K	10MM	DC12V	1950Lm	18w/m

LL-2835-240LED-(10MM) 12V/24V



6k

4k

3k



## Description

1. Made by 2835 Top LEDs with latest technology
2. Designed to consistent the current and voltage of strip from the front to the end which have only 5% current differences
3. Max. working length up to 5M by one end powered
4. thick 3oz PCB, heat transfer thermal tape, nice design package. LED with LM-80 Test approval.

Model No	LED Density	Color	Width	Work Voltage	Lumens	Peak Power
DG-2835-240LED-12V	240 leds/m	3K/4K/6K	10MM	DC12V	2380Lm	24 w/m
DG-2835-240LED-24V	240 leds/m	3K/4K/6K	10MM	DC24V	2380Lm	24 w/m

LL-2835-120LED-(8MM)-COLOR 12V



ICE BLUE  
LEMON GREEN  
BLUE  
PINK  
AMBER  
RED  
GREEN  
ORANGE  
PURPLE



## Description

1. Made by 2835 Top LEDs with latest technology
2. Designed to consistent the current and voltage of strip from the front to the end which have only 5% current differences
3. Max. working length up to 5M by one end powered
4. thick 3oz PCB, heat transfer thermal tape, nice design package. LED with LM-80 Test approval.

Model No	LED Density	Color	Width	Work Voltage	Peak Power
DG-2835-120LED-12V (COLOR)	120 leds/m	COLOR	MM	DC12V	15 W/M

LUXURIA

LED  
STRIPS

24V-2835 -120 LED STRIP  
6 Oz PCB

NEW

20 Meter by one end powered  
Head Brightness = End Brightness, only 5% difference

LONG RUN

20M

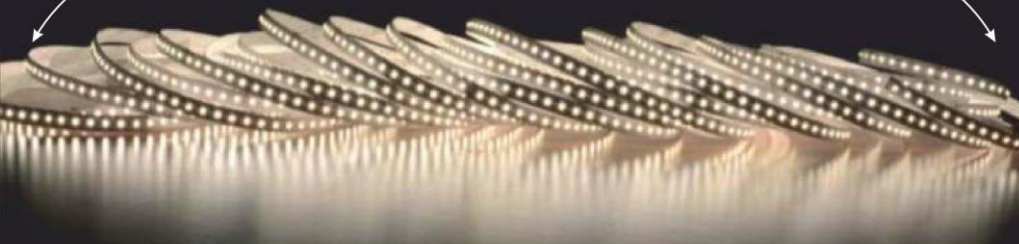

ULTRA LENGTH 20M/ROLL  
24V-2835 -120 LED STRIP  
6 Oz PCB

ZERO DROP  
LED STRIP

4k

3k



#### Description

LED Type	:	2835
Watt/M	:	10.8W
Voltage	:	24V
LED Qty	:	120
lm/LED	:	26-28lm
Beam Angle	:	120
IP Rating	:	Ip20
Width	:	10m
PCB	:	6 OZ



# WATERPROOF LED STRIP



Voltage	Series	Led	Mm
12V	2835	60led	10mm
12V	2835	120led	10mm
12V	2835	180 led	12mm
12V	2835	240led	12mm
12V	5050	60led	10mm
24V	2835	120led	10mm
24V	2835	240led	12mm





## POWER SUPPLY

LL



Inrush Current(Typ.): Cold Start 120A/220VAC

Protection Short circuit: Protection type:recovers automatically after fault condition is removed

Overload over: load protected@115-140% above peak rating

Over temperature: protection type:shut down o/p voltage,re-power on to recover

Working temp: -30 +50 (Refer to output load derating curve)

Working Humidity: 20 99%RH non-condensing

Storage Temp,humidity: -40 +8 ) 99%RH

12V-60W	24V-60W
12V-100W	24V-100W
12V-150W	24V-150W
12V-200W	24V-200W
12V-300W	24V-300W



# LED SKYLINE LIGHT



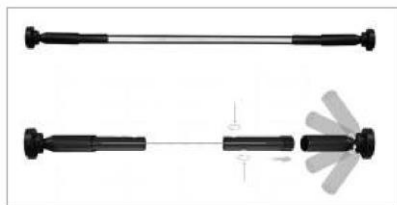





## LINEAR LED BAR LIGHT



Skyline Base	Skyline Belt	Stainless steel scissor
		
Skyline Base for flexible belt, 300 Degree angle adjustable.	Flexible Stainless belt for LED Strip Cuttable by scissor Belt Width: (20mm/0.787in) Applicable width of led strip: (13mm/0.51in)	Scissor for cutting Stainless belt

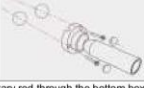

### Installation Procedure

 <p>On the installation wall, drill <math>\phi 10\text{mm}</math> (0.394in) holes with a distance of 40mm (1.58in), and install the Plastic plug</p>	 <p>Connect the DC wire to the terminal of the bottom box. The wire is recommended to be 16 20AWG single copper wire.</p>	 <p>Paste the LED strip on the steel strip, the beginning position should be 60mm (2.36in) away from one end of the steel strip.</p>	 <p>Fix the steel strip to the screw rod. The steel strip which side with a quick plug terminal should be fixed to the screw rod marked A.</p>
 <p>Put the rotary rod through the bottom box, and fix the bottom box onto the wall. Please fix the rotary rod marked A to the bottom box with terminals.</p>	 <p>Measure the distance (L) between the installation walls with wire rope, and the cutting length (X) of the rope should be 240mm (9.45in) shorter</p>	 <p>Fix the screw rod with the rotary rod. Tighten the steel strip by turning the rotary rod.</p>	 <p>Plug the quick plug terminal into the bottom box.</p>

# LINEAR FLEX

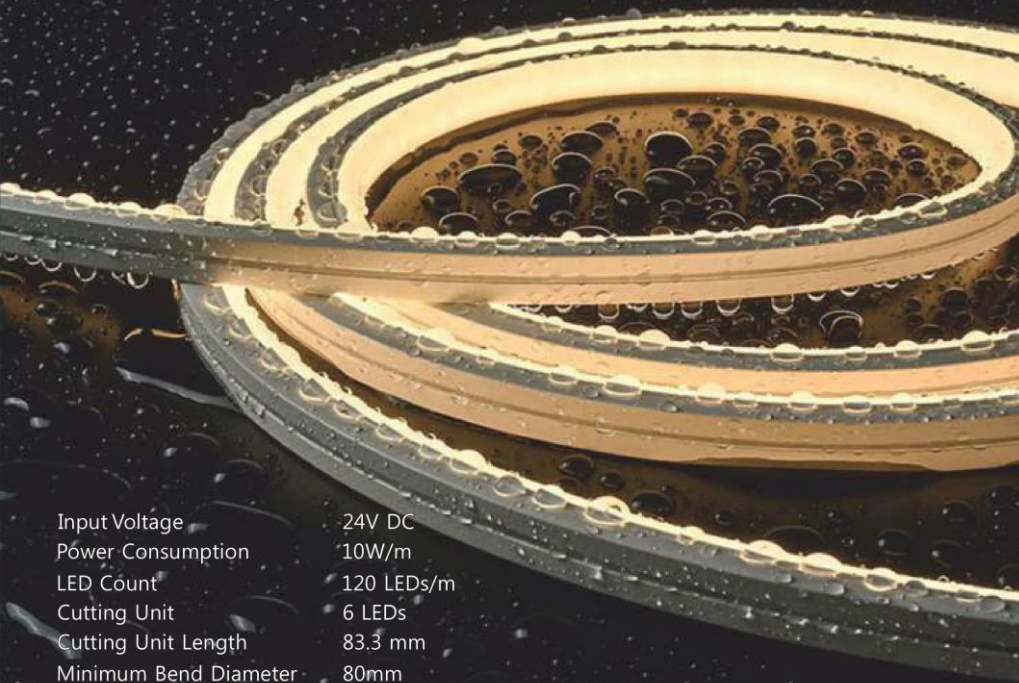

Input Voltage	24V DC
Power Consumption	10W/m
LED Count	120 LEDs/m
Cutting Unit	6 LEDs
Cutting Unit Length	83.3 mm
Minimum Bend Diameter	80mm
LED Light	Epistar SMD LED 2835 >80, >90
Max Run Length*	
Single	10M
Double Feed	20M
Beam Angle	120°
Lumen Maintenance	70,000 Hours L70 @ 25°C 50,000 Hours L70 @ 50°C
Temperature Ranges	
Installation	0°C to 50°C
Operating	-40°C to 55°C

LINEAR FLEX WITH LED  
24V - 2700k  
24V - 4000k

LUXURIA



## TOP VIEW

LL-24V-LF-T02

LL-24V-LF-T04

3k 4k

-24V-LF-T02



SIZE  
12 X 12  
TOP VIEW

ENDCAP



MOUNTING BACK CLIP



FLEXIBLE CLIP



ALUMINIUM PROFILE



-24V-LF-T04



SIZE  
16 X 16  
TOP VIEW

ENDCAP



MOUNTING BACK CLIP



FLEXIBLE CLIP



ALUMINIUM PROFILE



## SIDE VIEW

LL-24V-LF-S02

LL-24V-LF-S03

3k 4k



LL-24V-LF-S02



SIZE  
6 X 12  
SIDE VIEW

ENDCAP



MOUNTING BACK CLIP



FLEXIBLE CLIP



ALUMINIUM PROFILE



LL-24V-LF-S03



SIZE  
12 X 20  
SIDE VIEW

ENDCAP



MOUNTING BACK CLIP



FLEXIBLE CLIP



ALUMINIUM PROFILE



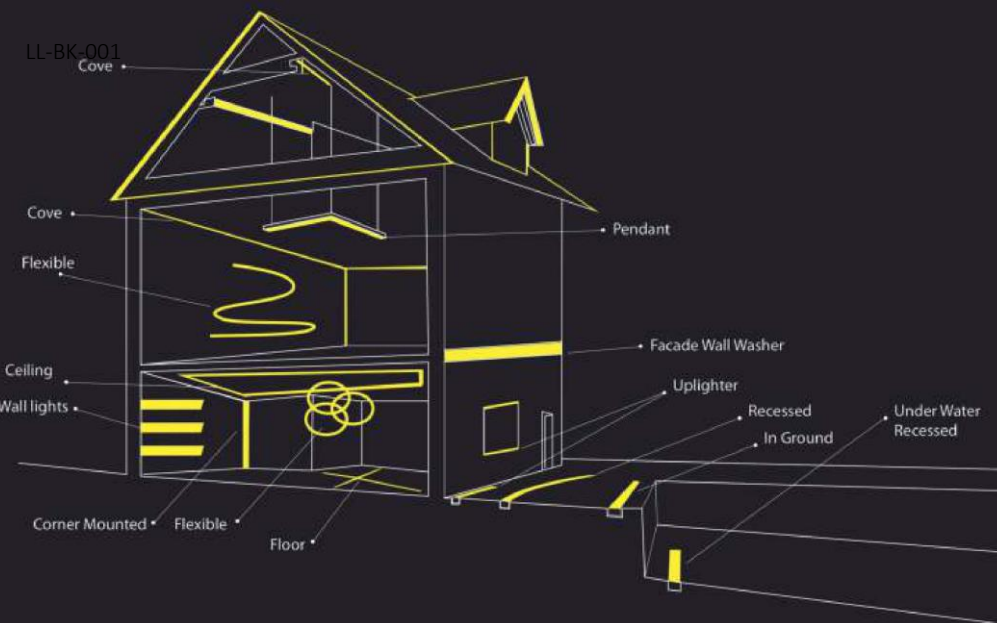

LUXURIA